

Milli-Q® HX 7000

High-Throughput Water
Purification Systems

Connected, sustainable central pure
water solutions for up to 9000 L daily.



Now with MyMilli-Q™
Remote Care

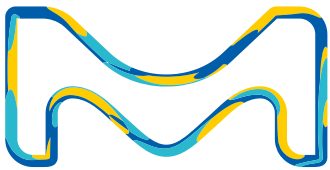

The life science business
of Merck operates as
MilliporeSigma in the
U.S. and Canada.

Milli-Q®
Lab Water Solutions

Milli-Q® HX 7000 Series

A modern range of high-throughput systems backed by decades of water purification expertise

Expertise to match today's changing laboratory environment

Laboratories around the world are evolving continually to keep pace with growing research requirements, new ways of sharing scientific information, the trend toward connectivity, and increasingly stringent environmental regulations. Adapting space and equipment to meet these new needs can be challenging for all involved.

As part of this process, your responsibilities may involve renovating or expanding existing labs — or planning, designing, and engineering entirely new facilities. In either case, you may need to specify water purification systems. That's where our expertise is key.

We have over 50 years of experience in the water purification business. Our products are designed to improve the quality and reliability of results — from research laboratories to QA/QC laboratories in the pharmaceutical industry.

Based on our extensive knowledge of laboratory applications and equipment, pharmaceutical

industry requirements, and water purification technologies, we can help you select the appropriate water purification solution: a comprehensive total water purification package for a single laboratory, a suite of laboratories — or an entire laboratory building.

Our Milli-Q® HX 7000 water purification systems and SDS 500 (storage, protection and distribution systems) can be combined in compact and modular installations. One or more Milli-Q® HX 7000 systems can be provided in order to ensure the right water quality and quantity for each laboratory or department, and thus avoid very long distribution loops, which can encourage

bacterial contamination. Such installations are not only easier to maintain and sanitize, but also offer greater flexibility in the event that adjustments are required for future lab upgrades or configuration changes. There is also the added benefit of redundancy in case a system backup is ever required.

Point-of-use Milli-Q® IQ 7000 polishing systems can be added throughout the installation as needed, in order to meet ultrapure water quality needs for more sensitive applications.



A total water purification systems partnership

To meet a customer's specific requirements, we work closely with stakeholders throughout the different project stages. End-user scientists, architects, consultants, lab and facilities managers, as well as contractors and equipment suppliers all have their own criteria that must be evaluated before any decisions can be made.

We help establish key parameters for the installation, including water quality and quantity, industry standard requirements, and considerations for long-term laboratory use. We're your partner throughout the project.

A comprehensive solution to match your needs

Purified water is required for a wide range of applications within a laboratory facility. The water quality needed can range from general laboratory grade to ultrapure water matching the sensitivity of critical research and analytical techniques. In addition, the water quantity can vary from a few liters for a single end-user to several hundred or thousand liters per day for a laboratory facility.

Our Milli-Q® HX 7040/7080/7120/7150 range is designed for customers who require a few hundred liters to up to several thousand liters per day of analytical-grade water. Placed at the heart of a total pure water solution, a Milli-Q® HX 7000 high-throughput system and accompanying SDS 500 pure water reservoir can be connected to additional components and accessories in order to build a comprehensive water purification system to match a customer's specific needs.



We are your partner of choice for total water purification systems — from conception and design, right through to engineering expertise and technical support services.

A Total Water Purification System requires the main water purification system to be integrated into a centralized system.

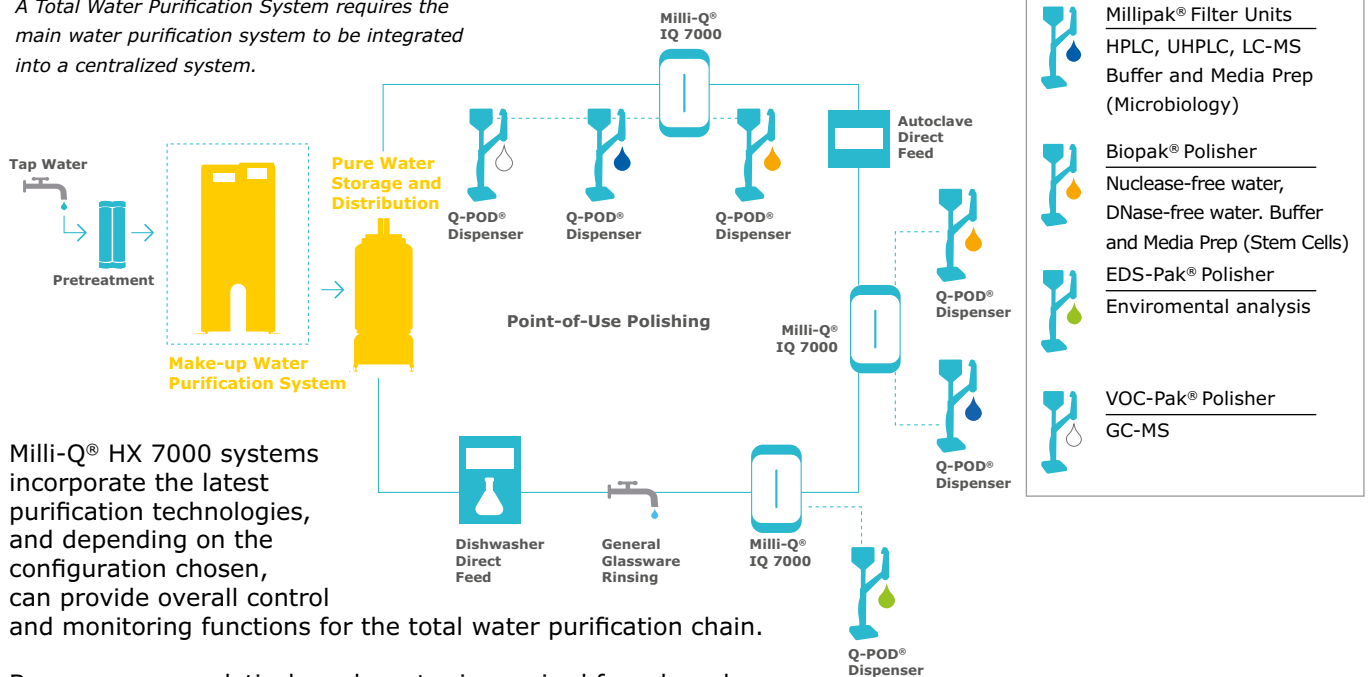

Milli-Q® HX 7000 systems incorporate the latest purification technologies, and depending on the configuration chosen, can provide overall control and monitoring functions for the total water purification chain.

Because pure analytical-grade water is required for a broad range of laboratory applications, Milli-Q® HX 7000 systems are a perfect fit for labs everywhere, including those in the pharmaceutical, clinical, chemical, metallurgical, cosmetics, food & beverage, electronics and biotech sectors.

Product water from Milli-Q® HX 7000 systems is suitable for the following applications:

- Microbiological media preparation
- Buffer preparation
- Hydroponics
- Manufacturing chemical and biochemical reagents
- Pharmaceutical laboratories

Pure water produced by the Milli-Q® HX 7000 system meets or exceeds water quality levels described by the following organizations:

Standard version as of Nov 2019	Water Quality/Grade as of Nov 2019
ISO 3696:1987	Grade 2 Water for analytical laboratory use
Chinese National Standard GB/T6682-2008	Level 2 Water
ASTM® D1193-06 (2018)	Type II Water
JIS K 0557-1998 (R 2012)	A3 water
European Pharmacopoeia 9 th edition 2019 (9.8)	Purified Water in bulk
European Pharmacopoeia 10 th edition 2020 (applicable from 1 Jan 2020)	
United States Pharmacopoeia (USP 42-NF 37)	Purified Water
Chinese Pharmacopoeia 2015 edition	Purified Water
Japanese Pharmacopoeia 17 th edition	Purified Water

The Compliance Report on Milli-Q® HX 7000 Series conformity to industry norms is available upon request.

The table below gives minimum specifications for different water types*

Contaminant	Parameter (unit)	Type 3	Type 2	Type 1
Ions	Resistivity (MΩ·cm)	> 0.05	> 1.0	>18.0
Organics	TOC (ppb)	< 200	< 50	< 10
Pyrogens	EU/mL	NA	NA	< 0.03
Particulates	Particulates >0.2 µm (units/ml)	NA	NA	< 1
Colloids	Silica (ppb)	< 1000	< 100	< 10
Bacteria	Bacteria (cfu/mL)	< 1000	< 100	< 1

*These values are provided only as guidelines, as some specific laboratory applications may require a quality superior to the quality indicated by the norms.

At the heart of your total pure water solution

A total pure water solution consists of not just one system, but rather several integrated parts. At the heart of the solution, the Milli-Q® HX 7000 system serves as the nerve center for the entire water

purification chain, and provides total control of all functions, operating parameters and standard accessory components.

The Milli-Q® HX 7000 water purification system

- Functions as the makeup water system
- Using a combination of technologies, purifies tap feed water to produce sufficient volumes of the required water quality for use in all the laboratories.

An SDS 500 unit for storage, protection and distribution of pure water

- The SDS unit stores purified water from the Milli-Q® HX 7000 makeup system, helping to meet daily needs and cover peak periods of high demand from the labs. It is important to ensure that the Milli-Q® HX 7000 water production rate and the tanks are sized to meet the labs' daily and peak usage demands for purified water.
- The SDS unit also distributes and maintains top-quality pure water through the piping network at the correct flow rates and pressures. In-line UV lamps and integrated final 0.22 µm sterile filtration devices maintain/improve the quality of distributed water.

See page 9 for more information on the SDS 500 unit.

Point-of-use delivery and polishing

Throughout the piping distribution network, pure water can be used for a variety of purposes:

- Feed to instruments, clinical analyzers, dishwashers or autoclaves
- General glassware rinsing
- Buffer and media preparation
- Feed to high-throughput ultrapure water purification systems (Super-Q® systems) or point-of-use "polishing" systems, such as Milli-Q® IQ 7000 systems.



Inside the Milli-Q® HX 7000



**State-of-the-art
complementary purification
technologies**

**Progard® pretreatment packs combine
several purification media to protect the
Milli-Q® HX 7000 system by removing:**

- Particles (0.5 µm filter)
- Free chlorine and colloids (activated carbon filter) from tap water

**Other pretreatment such as backwashable
carbon filters and ultrafiltration can be
added depending on your feed water quality.**

Advanced RO and E.R.A.® technologies decrease water consumption

- Advanced reverse osmosis removes 95-99% of ions and 99% of all dissolved organics (MW > 200 Dalton), microorganisms and particles.
- Evolutive Reject Adjustment (E.R.A.®) technology uses an integrated calculator to optimize RO water recovery (between 45 and 75%) depending on feed water quality.
 - Production flow and water recovery rates remain constant regardless of feed water temperature.
 - No manual adjustment of valves is needed to maintain flow rate or protect RO cartridge lifetime.
 - Users save water, time and money.
 - Maintenance time is reduced, as well as the risk of human error.
 - System uptime is optimized and reliability increased.

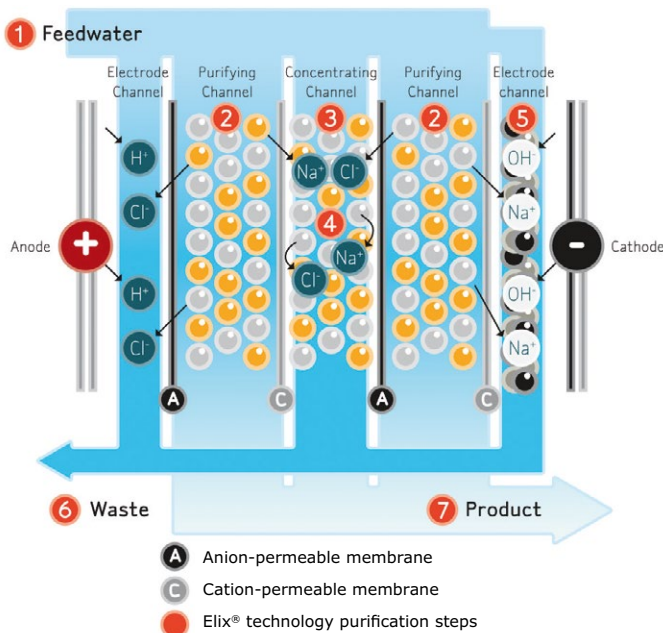
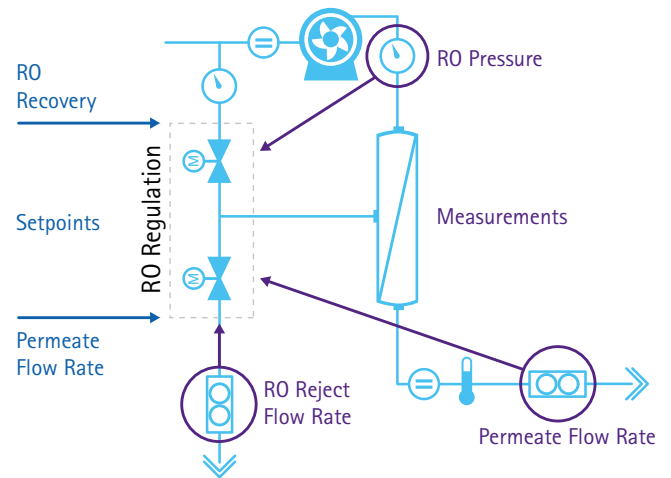

The Elix® EDI module ensures constant quality pure water, productivity and profitability

- Remaining ions are removed in the Elix® electrodeionization (EDI) module, where ion-exchange resins are continuously regenerated by an electric field. No hazardous chemical regeneration or costly resin replacement is needed.
- There are no DI cartridges to change, which reduces maintenance time and ensures low and predictable running costs.
- Regardless of feed water quality (conductivity, CO₂ levels), or RO cartridge performance, both running costs and product water quality remain the same — there are no unexpected costs for users.
- Elix® patented technology does not require softeners; labs save space and maintenance time.

Elix® module: our unique EDI technology is based on anion- and cation-permeable membranes and high-quality ion-exchange resin. Water produced by the Elix® module enters the tank with resistivity greater than 5 MΩ·cm @ 25 °C (typically up to 15 MΩ·cm @ 25 °C).

UV lamp and final filtration for full bacterial control

Optimum-quality Elix® water is well-suited for bacteria-sensitive applications.

UV lamp sanitization occurs at three stages, reducing the water's bacterial count by a log of 4⁺:

- During water production
- During storage in the SDS 500 reservoir (see page 9 for more information)
- During recirculation in the distribution loop
- Before water is delivered, a pharmaceutical grade Opticap® filter (0.22 μm) provides final filtration

* Patent pending

† E.g., In a well-designed and maintained distribution loop, a bacterial count of 10,000 cfu/mL is reduced to 1 cfu/mL, irrespective of the system's nominal flow rate.

Milli-Q® HX 7000 series

Water Purification Systems

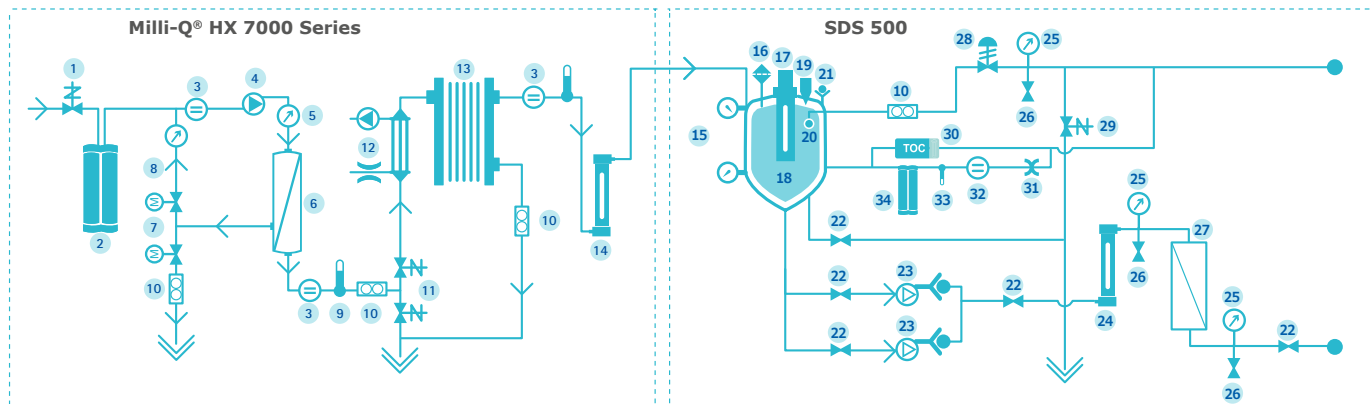

- | | | |
|--|---|---|
| 1. Inlet valve | 13. Elix® module | 25. Pressure gauge |
| 2. Progard® pretreatment pack | 14. UV lamp (254 nm) | 26. Sampling valve |
| 3. Conductivity cell | 15. Tank level pressure sensors | 27. Opticap® filter (0.22 µm) |
| 4. RO pump | 16. Vent filter | 28. Back pressure regulator |
| 5. Pressure sensor | 17. Automatic Sanitization Module (ASM) (UV 254 nm; option instead of spray ball) | 29. Automatic loop rinsing valve |
| 6. RO cartridge | 18. Tank | 30. TOC monitor (option) |
| 7. Twin motorized valve - RO recirculation | 19. Overflow | 31. 4 LPM flow controller (option with Resistivity booster) |
| 8. RO circulation loop | 20. Spray ball | 32. Resistivity cell (option) |
| 9. Temperature sensor | 21. Check valve | 33. Temperature cell (option) |
| 10. Flow sensor | 22. Valve | 34. Resistivity booster (option) |
| 11. 3-way automatic rinsing valve | 23. Distribution pump(s) | |
| 12. Degassing unit (option) | 24. UV lamp (254 nm; option) | |



Full online monitoring & control of the installation and water quality parameters

Milli-Q® HX 7000 systems drive and control all additional equipment needed in an installation, including:

- Single and duplex distribution pumps and their alarms
- Bactericidal UV lamp in the distribution loop*
- Automatic Sanitization Module (ASM)* on the SDS 500 unit
- Storage tank levels and alarms
- Vent and final filter consumable management
- TOC and resistivity monitoring in the distribution loop, depending on the configuration chosen
- Water detector to stop water production and distribution in case of a leak*

Following each purification step, the Milli-Q® HX 7000 system checks relevant parameters:

- Feed pressure, feed water quality
- RO pressure, RO water quality, RO membrane efficiency (% ion rejection)
- Elix® water: resistivity and temperature
- Water quality in the loop return (resistivity and/or TOC*) can also be checked by the system

* Available as an option

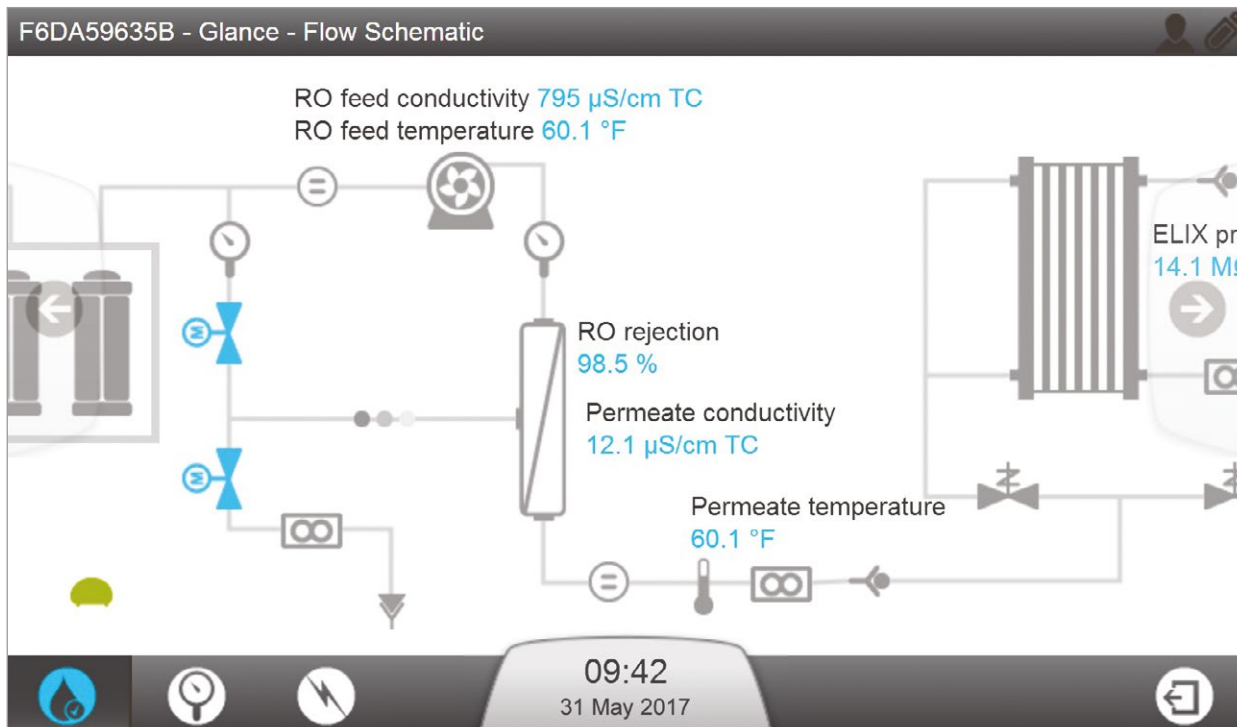

Compact SDS 500 storage unit protects water purity for efficient distribution

The SDS 500, with its state-of-the-art design, is the perfect companion for the Milli-Q® HX 7000 series of systems:

- Distribution flow up to 60 L/minute; single or duplex pump options
- Polyethylene tank with IR polypropylene piping
- Hermetically sealed lid with no overflow to drain prevents bacterial contamination
- Optional Automatic Sanitization Module (ASM) with integrated 254 nm UV lamp prevents bacterial and biofilm growth on tank inner surfaces
- Optional spray ball cleans the tank cover with high pressure
- Constant velocity in the loop limits biofilm buildup
- Cylindrical shape and conical bottom for full drainage
- Vent filter protects against airborne contaminants
- Differential pressure sensor for accurate level measurement
- Sanitary connection; sanitary sampling port located anywhere in the loop

Connectivity Assures Productivity



Discover MyMilli-Q™ Remote Care monitoring and service capability that supports your lab's maximum productivity

What can MyMilli-Q™ Remote Care help you to achieve?

- **Assure productivity 24/7.** Access real-time system information, water quality data and more from anywhere at any time for 24/7 confidence in your lab's performance.
- **Save time.** In the event you need support, your interaction with Milli-Q® Services is streamlined as MyMilli-Q™ Remote Care provides our service organization a secure and direct view of your system information. Our service teams can remotely diagnose and potentially repair your system, avoiding the need to wait for a service visit.
- **Maximize uptime.** Receive notification of alerts and alarms allowing you to promptly and remotely manage your system, either independently or with our remote assistance.
- **Easier data traceability & accreditation.** Audit preparation and lab accreditation have never been so effortless as data are automatically saved and can be easily accessed, searched and retrieved. Choose to download a standard Quality Report, or to create your own tailored reports.

The screenshot displays the MyMilli-Q Remote Care web interface. The main content area shows the 'Equipment Details' for a Milli-Q HX 7120 system. The details table is as follows:

Equipment name
Milli-Q® HX 7120 230V 50/60 Hz
Serial
F4PA43024A
Asset number
ABC123
Location
Quality Pharma
Software package
46

The sidebar on the right contains the following elements:

- 2 CONTACT HOTLINE
- 3 REMOTE CONNECTION
- 4 GENERATE QUALITY REPORT
- 5 FILE MANAGEMENT
 - TECHNICAL DOCUMENT
 - USER MANUAL
 - QUALITY REPORT
 - QUALITY DOCUMENTATION
 - OTHER MANUAL

Numbered callouts (1-6) highlight key features:

- 1 Quickly view all system details.
- 2 Send a direct message to Milli-Q® Services.
- 3 Access and remotely control your system's interface.
- 4 Instantly generate a Quality Report over the timeframe you specify.
- 5 Find all system documentation and generated reports.
- 6 Scroll down to view:
 - Real-time water quality parameters: resistivity, temperature and TOC
 - Service contract information
 - History of service visits and reports
 - Current alarms and alerts
 - Interactive Event Traceability tool for a visual timeline of all system events
 - Graphs of water resistivity, temperature and TOC over your chosen timeline
 - Remaining lifetime of each consumables and consumable contracts

The MyMilli-Q™ Remote Care customer home page can be accessed online 24/7.

MyMilli-Q™ Remote Care facilitates data traceability & eases accreditation

Water is a reagent whose quality must be documented for laboratories seeking accreditation (or reaccreditation) to the ISO® 15189:2012 standard.

To facilitate compliance with worldwide regulatory organization guidelines, Milli-Q® HX 7000 systems allow for full monitoring capabilities as well as automatic e-record archiving both:

- **Directly in the system** — data are retrievable by USB key or via your lab’s intranet connection.
- **In the cloud** when MyMilli-Q™ Remote Care is activated.

E-record archiving supports traceability of all water-related daily operations, measurements and events. It saves time and is less expensive to manage versus paper documentation, as it removes the need for daily checks of the water purification system, hand-recording of parameters in a lab book, and physically archiving years of paper data.

With the user-friendly MyMilli-Q™ web interface and MyMilli-Q™ Remote Care service feature, data management is greatly simplified. Your system and water data are readily accessible and rapidly searchable, graphable and reportable — from anywhere at any time.

An interactive Event Traceability tool lets you view events by type and over the timeline you specify. View past events (alarms, alerts, consumable replacements, service visits, custom events) and plan for future system maintenance. Click on any event and its details are displayed in the blue banner above the timeline. In this example, a Progard® cartridge was replaced by J.SMITH on Aug 19, 2019.

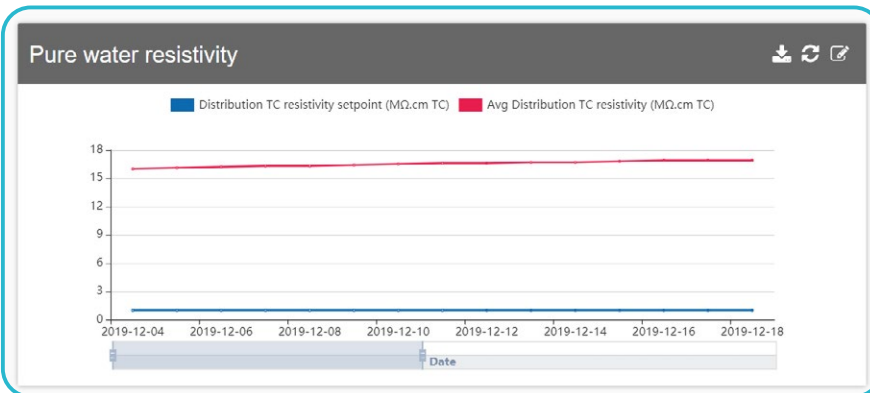
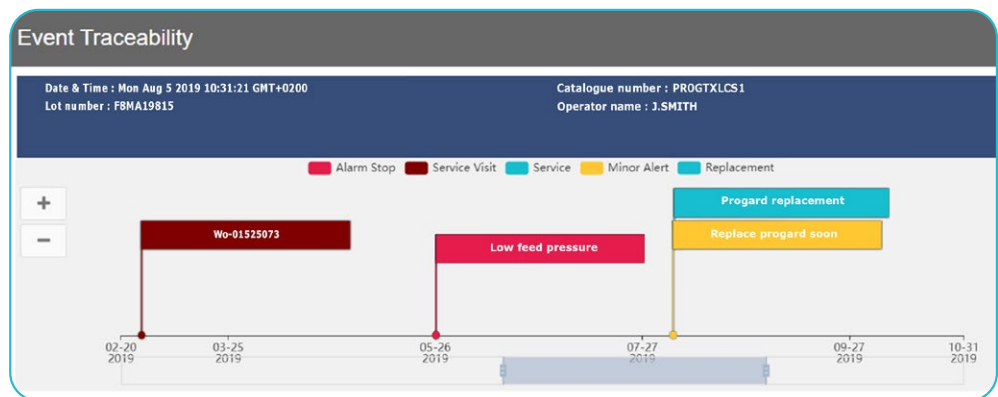

Water quality parameters (resistivity, temperature, TOC) are graphed over the timeline of your choice and can be easily downloaded.

The system automatically stores a fully traceable—and easily retrievable—record of service history. In addition to archiving data, MyMilli-Q™ online tool lets you streamline contract management. You’ll be able to schedule maintenance visits, manage consumable deliveries and renew your service contracts, all online.

Number	Type	Scheduled date	Status	Closed date	Attachments
WO-01552478	Preventive Maintenance	Oct-21-2020	Open	N/A	
WO-01484798	Preventive Maintenance	Oct-23-2019	Billed	Oct-23-2019 17:51:51	
WO-01414935	Repair	Apr-25-2019	Billed	Apr-25-2019 17:29:55	
WO-01319139	Preventive Maintenance	Oct-22-2018	Billed	Oct-22-2018 18:42:39	
WO-01224863	Installation	Oct-18-2017	Billed	Oct-18-2017 15:22:14	

Intuitive use with a superior communications interface

A large, colored touchscreen gives users all details needed for daily system operations at a glance. Easily navigate to view data, including:

- Production status
- Dispensing status
- Consumables status
- Storage levels
- System settings
- Preventative alarms and alerts

Information is displayed in a user-friendly, easy-to-read dashboard format.

System status zone

Large display shows water qualities and distribution process

Clear, visible status of all consumables

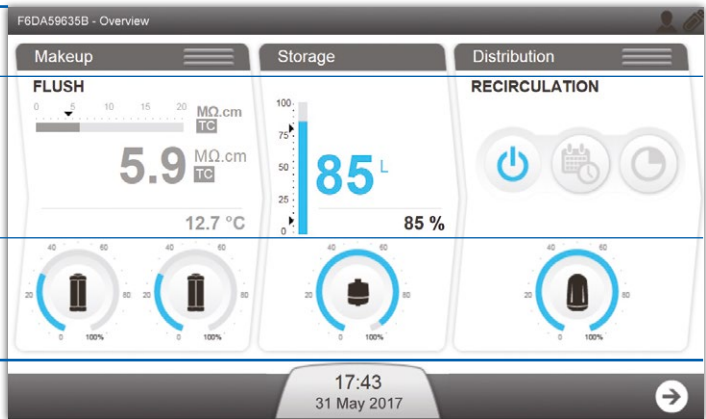

Notification zone for alerts and alarms

If a consumable change is required, the system will display a yellow, blinking alert 15 days in advance. Just touch the yellow alert to open a new screen...

Now you can view and control your system's interface remotely via MyMilli-Q™ Remote Care. See pages 10-11 for more information.



... where a wizard will explain the maintenance procedure in easy, step-by-step instructions.

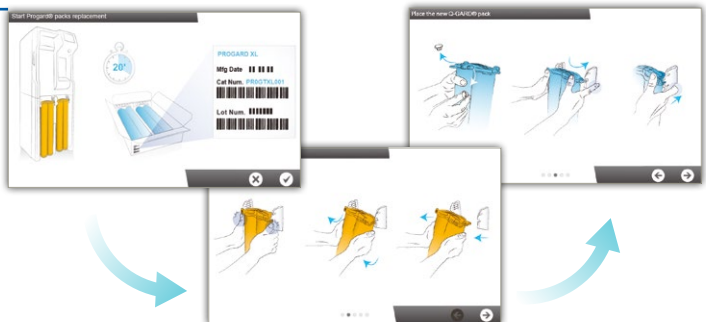

A sustainable solution, today & tomorrow

We are committed to environmental sustainability. Ongoing developments in Lab Water product stewardship underscore our determination not only to increase our own product sustainability, but also to help our customers move toward sustainable solutions themselves.

Our efforts include using optimized purification technologies that help decrease energy and water consumption, and reducing packaging and documentation.

Milli-Q® HX 7000 systems incorporate patented Elix® technology, which provides constant-quality water without the need for resin cylinders, softeners, or conditioning systems. In addition, integrated E.R.A.®

technology automatically optimizes water recovery based on feed water quality to decrease tap water usage — up to 50% compared to other high-throughput RO systems — reducing costs and helping protect valuable resources. The RO recovery loop also optimizes water consumption (between 45 to 75%) by recycling part of the water that has been rejected to the drain, thus further reducing water waste and also extending RO cartridge and Progard® pack lifetimes.

In a busy laboratory environment with a variety of equipment — often installed in a relatively small space — Milli-Q® HX 7000 systems also help reduce noise pollution with an operating noise level of less than 50 decibels (at a distance of one meter).

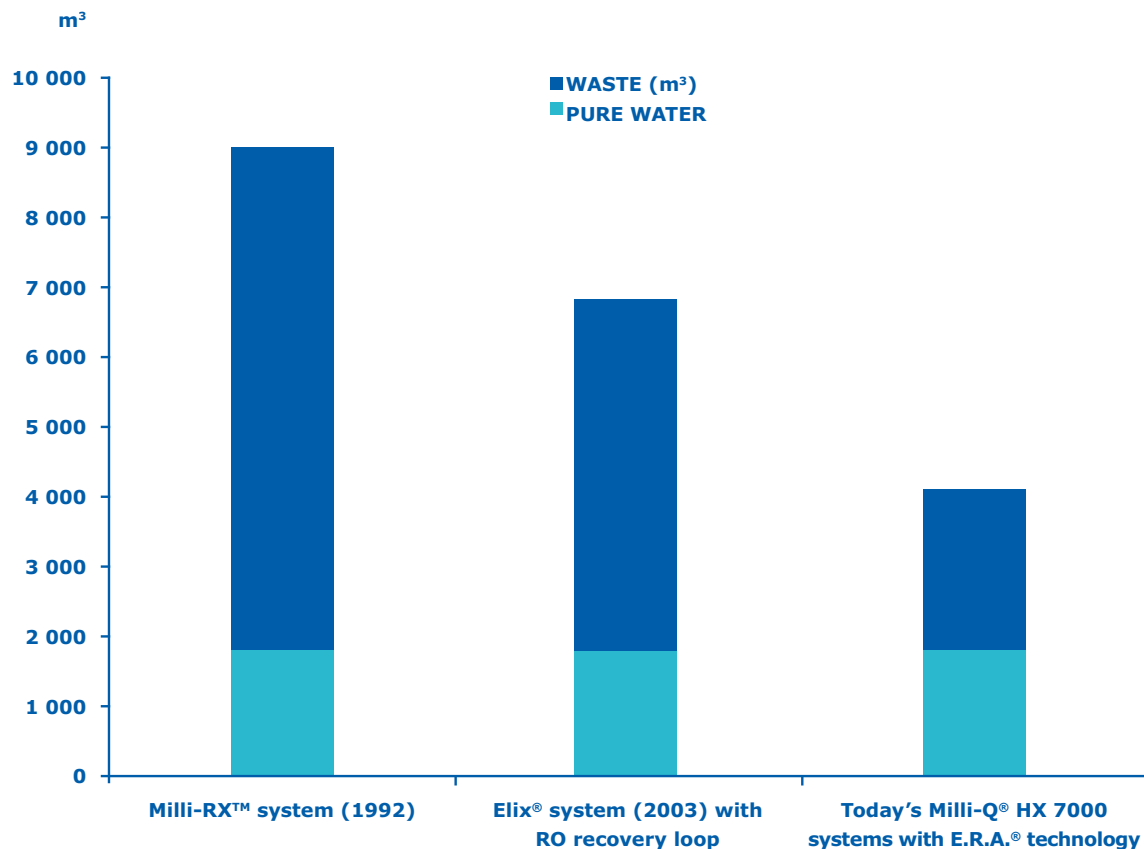

Over the last 25 years, we have dramatically reduced water purification system water consumption, enabling laboratories to save up to several thousand dollars per year on tap water expenses. The graph shows water consumption and the split between purification system

water and reject water for three of our water purification systems over a seven-year period (production of 1000 L/day of pure water, 312 days per year).

Best-in-class Milli-Q® Services, now supported by MyMilli-Q™ Remote Care

Receive unequalled quality of support for complete peace of mind throughout your system's lifetime

At each stage of your project (conception, design and installation) to everyday use, we offer comprehensive, high quality support services that can be customized to meet your needs.

- **Before installation**, a certified field service engineer analyzes your feed water quality.
- **During installation**, feed water parameters are programmed into system memory to optimize water recovery and maximize system performance.
- **Throughout system lifetime**, apply the **Milli-Q® Service Plan** that meets your lab's needs, from a single annual Preventive Maintenance Visit with replacement of aging parts, to full system coverage.
- **Choose from a range of additional options**, including qualification, calibration and verification services, scheduled consumables shipments, and sanitization.

Our certified field service engineers can provide:

- Operator training
- Technical and maintenance support
- Preventive maintenance
- Customized services, such as conductivity and temperature meter verification
- Assistance to help you successfully perform the Installation Qualification (IQ), Operational Qualification (OQ) and maintenance program within a cGMP and/or GLP environment

Final User / Laboratory

Architect, Engineer, Design & Facility Needs



- Configuration options based on the user's environment and specific needs (central or individual water purification solution with additional point-of-use systems)

- Selection of the optimal systems
- Support for loop design based on our 50 years of experience

- Design Qualification of the complete solution

- System installation
- Support for the loop sub-contractor

* Subject to subscription

 Specific to pharmacopeia and accredited labs

Log into MyMilli-Q™ online solution to streamline the care of your Milli-Q® system fleet:

- Track service history & reports
- Plan maintenance visits
- Manage consumable deliveries
- Renew service contracts
- Remotely monitor, control & service your system (via the MyMilli-Q™ Remote Care feature, see pages 10-11 for more information)

Our stringent Quality system, product development process and manufacturing procedures ensure that our products are robust and reliable. Milli-Q® HX 7000 systems are manufactured in an ISO® 9001- and ISO® 14001-registered site. Additionally, to ensure efficiency and safe operation, systems are IEC-certified (CE, cULus, FCC, EAC).

Furthermore, to reduce environmental impact, all Milli-Q® HX 7000 systems follow European Restriction of Hazardous Substances (RoHS) and Waste Electrical and Electronic Equipment (WEEE) directives.

SigmaAldrich.com/milli-qservices

y Needs

Full Solution Qualification



Training

Lifetime Services

- | | | |
|---|---|---|
| <ul style="list-style-type: none"> ● Installation Q ● Operational Q ● Maintenance Procedure ● Calibration ● Verification | <ul style="list-style-type: none"> ● Users ● Maintenance Department ● Quality controller & assurance expert | <ul style="list-style-type: none"> ● Milli-Q® Service Plans* ● MyMilli-Q™ online solution* ● MyMilli-Q™ Remote Care* ● Technical support hotline ● Maintenance Protocol ● Traceability |
|---|---|---|

Technical Appendix



Milli-Q® HX 7000 series system
paired with the SDS 500

Milli-Q® HX 7000 series

Type 2 Water Purification Systems

System Dimensions

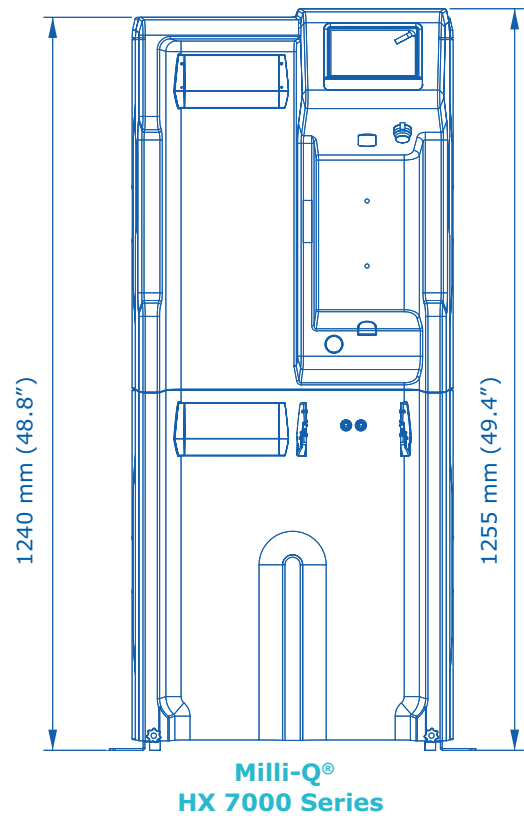
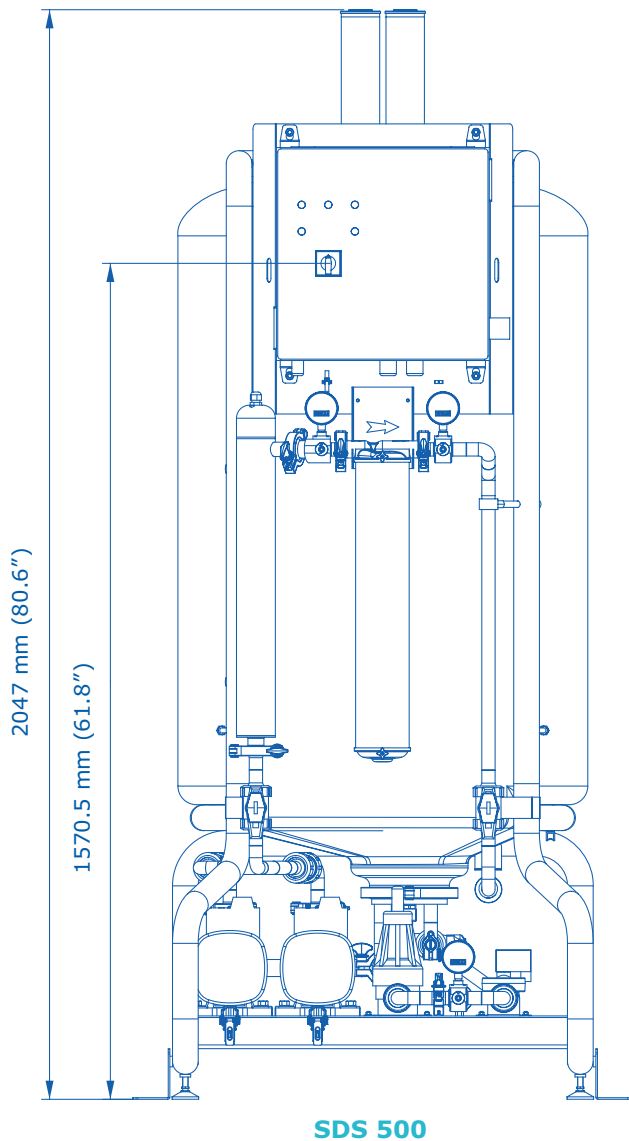

Milli-Q® HX 7000 series

Type 2 Water Purification Systems

Feed Water Requirements

Parameter	Value or Range
Pressure	2 – 6 bar
Flow rate	> 10 L/min at 2 bar
Feed water type	Potable water
Temperature	5 – 35 °C
Conductivity	10 – 2000 µS/cm at 25 °C
pH	4 – 10
Hardness (as CaCO ₃)	< 300 ppm
Silica concentration	< 30 ppm
Carbon dioxide concentration (CO ₂)	< 30 ppm
Langelier Saturation Index (LSI)	< 0.3
Fouling Index (FI _s) or Silt Density Index (SDI)	≤ 7(*)
Total Organic Carbon (TOC)	< 1 ppm
Free chlorine for Milli-Q® HX 7040 LC, 7080 LC, 7120, 7150 systems	< 1.5 ppm
Free chlorine for Milli-Q® HX 7040 HC, 7080 HC systems	< 1.5 ppm – 3 ppm

* < 12 when the optional UF pretreatment is installed.

Milli-Q® HX 7000 Series Performance

Parameter	Value or Range
Resistivity	> 5 MΩ.cm @ 25 °C (10-15 MΩ.cm @ 25 °C typically)
Conductivity	< 0.2 µS/cm @ 25 °C
Total Organic Carbon (TOC)	Typically < 30 ppb
Microorganisms	< 10 cfu/mL
Dissolved silica	< 3 ppb (rejection >99.9%)

Electrical Specifications

System Type	Voltage / Frequency	Power Consumption (VA)
Milli-Q® HX 7040/7080	220-240 VAC, 50/60 Hz	750
	120 VAC, 60 Hz	775
	100 VAC, 50/60 Hz	
Milli-Q® HX 7120/7150	220-240 VAC, 50/60 Hz	870
	120 VAC, 60 Hz	900
	100 VAC, 50/60 Hz	

General Specifications

Noise level	< 50 dB at 1 meter
Communication protocol	TCP/IP/CGI, embedded web server and HTML 5 embedded website*
Communication ports	Ethernet, USB 2.0
Languages	English, French, Spanish, Portuguese, Italian, German, Russian, Chinese, Japanese

* No additional software needed for remote control.

Dimensions and Weights

	Milli-Q® HX 7040	Milli-Q® HX 7080	Milli-Q® HX 7120	Milli-Q® HX 7150
Dimensions (H x W x D) footprint	1 240 x 543 x 542 mm (48.8 x 21.4 x 21.3 in)			
Shipping weight	97 kg (213 lb)	105 kg (231 lb)	113 kg (249 lb)	124 kg (273 lb)
Dry weight	78 kg (172 lb)	86 kg (190 lb)	94 kg (208 lb)	105 kg (232 lb)

SDS 500

Storage, Protection & Distribution System

SDS 500 Specifications

Tank volume	500 L (132 Gallons)
Usable water volume	400 L (105 Gallons), <i>an additional volume of 100 L is reserved for low and high level security</i>
Weight (filled with water)	660 kg (1455 lb)
Weight (empty)	Up to 140 kg (308 lb)
Dimensions H x W x D	2047 x 790 x 1082 mm (80.6 x 31.1 x 42.6 in)
Floor space required	0.85 m ² (9.15 ft ²)
Noise level	E.g. 45.5 dB @ 1m (BPR = 1.5b / flow rate 20 L/min) E.g. 54.7 dB @ 1m (BPR = 4b / flow rate 40 L/min)

Pump Performances (Variable speed pumps)

Voltage / Frequency	Pump Performances
220-240 V, 50/60 Hz	Nominal: 16-40 LPM @ 1-4 bar
110-127 V, 50/60 Hz	4-9 GPM @ 14-58 psi
200 V, 50/60 Hz	Nominal: 16-40 LPM @ 1-3.5 bar*
100 V, 50/60 Hz	4-9 GPM @ 14-50 psi*

* At 90V, performance is reduced to 16-40 LPM @ 1-3 bar (4-9 GPM @ 14-43 psi).

Electrical Specifications

Voltage / Frequency	Maximum Power Consumption	Maximum Intensity
220-240 V, 50/60 Hz	2100 VA	< 9A
100-127 V, 50/60 Hz	2000 VA (120 V)	< 16A
	2000 VA (100 V)	< 20A

Materials

Tank	Medium density polyethylene (MDPE)
Frame	Epoxy painted passivated steel
Valves and fittings	Polypropylene, polyamides, EPDM
Piping	Beta Polypropylene Homopolymer (Beta PP-H)
Pump wetted parts	316 SST and tungsten carbide / carbon and EPDM seals
BPR wetted parts	Polypropylene, EPDM, PTFE
Pressure gauge	Inox 316 L
Other mechanical parts	Polyethylene terephthalate (PETP)

Plumbing Connections

Pure water inlet to tank	3/4" Sanitary TC
Tank drain	1 1/2" Sanitary TC
Tank loop inlet/return	1 1/2" Sanitary TC

Milli-Q®

Lab Water Solutions

Merck KGaA
Frankfurter Strasse 250
64293 Darmstadt, Germany

[SigmaAldrich.com/labwater](https://www.SigmaAldrich.com/labwater)

For more information on Milli-Q® HX 7000 systems, please visit:

[SigmaAldrich.com/milliqhighflow](https://www.SigmaAldrich.com/milliqhighflow)

© 2021 Merck KGaA, Darmstadt, Germany and/or its affiliates. All Rights Reserved. Merck, the vibrant M, Elix, Q-POD, Super-Q, MyMilli-Q, Progard, Millipak, Biopak, EDS-Pak, VOC-Pak, Opticap, Milli-Q, Millipore, E.R.A. and Milli-RX are trademarks of Merck KGaA, Darmstadt, Germany or its affiliates. All other trademarks are the property of their respective owners. Detailed information on trademarks is available via publicly accessible resources.

Lit. No. MK_BR5271EN Ver. 0.1
30167
09/2021