

User Manual

Milli-Q® IX 7003/7005/7010/7015



Table of contents

INTRODUCTION	1
System identification	1
Intended use	1
Installation component	2
Water process	3
QUICK START	5
Navigate the screen interface	5
Dispense pure water	7
Manage dispense reports	9
Exit screensaver	10
View & manage Alerts and Alarms	11
CONSUMABLE MENU	12
View & manage Alerts and Alarms	12
Consumables identification with card reading	13
INFORMATION MENU	14
System	14
History	14
Flow schematic	15
Troubleshooting	15
Contacts	16
SETTINGS MENU	17
Manager access (& password)	19
System configuration	20
Accessories	22
Alarm configuration	23
Connectivity	24
Date Time & Language	24
Units	25
MAINTENANCE MENU	26
Consumable installation wizards	27
Cleaning & Sanitization	30
ech ₂ o® UV lamps - mercury free	30
Depressurization	31
SELF HELP GUIDE	32
Troubleshooting tips	32
Icons	34
REQUIREMENTS AND SPECIFICATIONS	35
Water specifications	35
System specifications	37
Power and water consumption	39
Dimensions and weights	40
Ordering information	43
LEGAL INFORMATION & WARRANTY	45

INTRODUCTION

Congratulations!

Thank you for buying a Milli-Q® water purification system.

The Milli-Q® IX 7003/7005/7010/7015 water purification system produces pure water from a tap water source. Installation of this product should be performed by a qualified service representative with access to installation documentation.

This user manual is a guide to be followed during the normal operation and maintenance of a Milli-Q® IX 7003/7005/7010/7015 water purification system. It is highly recommended to fully read this manual and comprehend its contents before using the water purification system.

System identification

System	Catalogue number	Production flow rate	Voltage	Frequency
Milli-Q® IX 7003	ZIX7003T0C	3 L.h ⁻¹	100-240 V	50-60 Hz
Milli-Q® IX 7005	ZIX7005T0C	5 L.h ⁻¹	100-240 V	50-60 Hz
Milli-Q® IX 7010	ZIX7010T0C	10 L.h ⁻¹	100-240 V	50-60 Hz
Milli-Q® IX 7015	ZIX7015T0C	15 L.h ⁻¹	100-240 V	50-60 Hz

Manufacturing site:

Millipore SAS, 67120 Molsheim, France

For more information on your Milli-Q® system, please call your local representative or visit our website www.sigmaaldrich.com

Intended use

The Milli-Q® IX 7003/7005/7010/7015 system is intended to produce pure (type 2) water from a tap water source primarily for use in research and quality control in a variety of laboratories worldwide.

The product is designed to produce pure water with specific characteristics (refer to the requirements and specifications section) when it leaves the E-POD® unit, provided that it is fed with water quality within specifications and properly maintained as required by the supplier.

We do not warrant the product for any specific application. It is up to the user to determine if the quality of the water produced by the product matches their expectations, fits with norms/legal requirements and to bear responsibility resulting from the usage of the water.

The product is not intended to produce: water for injection, water for dialysis, sterile water for irrigation or injection, bacteriostatic water for injection, sterile purified water in containers, and sterile water for injection in container or ingestion. The product is not intended to be used in explosive environments according to ATEX Directive – equipment & protective systems intended for use in potentially explosive atmospheres. In addition the product is not intended as a Medical Device, including In-Vitro Devices.

Installation components

Milli-Q® IX 7003/7005/7010/7015 consists of at least 3 different components: water system (Milli-Q® IX 7003 on the photographs below), tank, and E-POD® unit.



1	Front view of a Milli-Q® IX 7003 water system	6	E-POD® unit (Point of Dispense of pure water) with screen interface
2	Front cover	7	POD dispenser (equipped with a Milli-pak® final filter on the photograph)
3	Front view of a Milli-Q® IX 7003 water purification unit, with the front cover removed	8	Dispensing wheel
4	Accessories holder	9	POD base
5	Rear view of a Milli-Q® IX 7003 system with its hydraulic and electrical connections	10	Storage tank (50L capacity on the photograph)

Note: The system can either have one IPAK Gard® cartridge (Milli-Q® IX 7003/7005 system) or two (Milli-Q® IX 7010/7015 system). On the photograph, the accessories holder is used to store the sanitization port tool and the RO cleaning tablets bottle (ROProtect C - SDS available on www.sigmaldrich.com).

Water process

The Milli-Q® IX 7003/7005/7010/7015 manages the production and the distribution of pure (Type 2) water from a tap water source. It is composed of three different sections:

- Water purification unit manages the production of pure water.
- Storage tank stores and maintains the pure water quality.
- Point of dispense (E-POD® unit) integrates the screen interface and manages the dispensing of pure water. At least one E-POD® unit is necessary and up to 2 E-POD® units can be installed in total.

Production flow-schematic

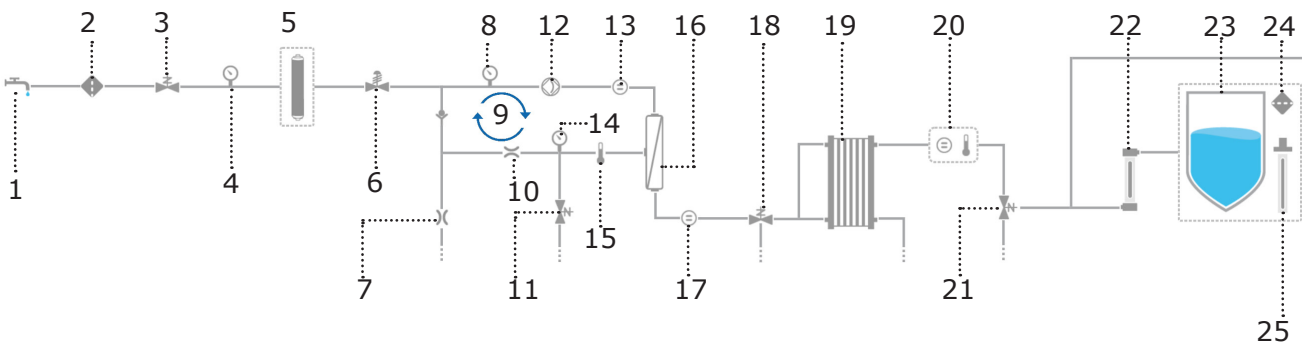

Distribution flow-schematic

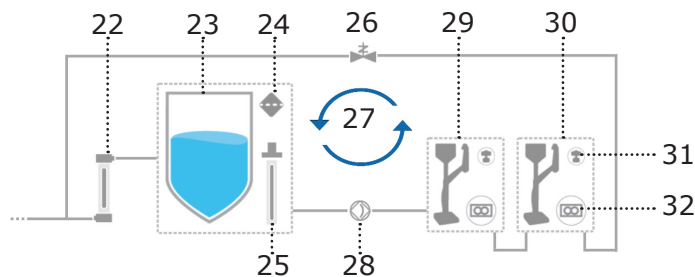

1	Tap feed water	17	Permeate conductivity cell
2	Inlet strainer	18	Permeate 3 ways valve
3	Inlet solenoid valve	19	Elix® EDI module
4	System feed pressure sensor	20	Pure water resistivity cell
5	IPAK Gard® (1 or 2 depending on system type)	21	Pure water 3 ways valve
6	Pressure regulator	22	ech ₂ o® bactericidal lamp
7	Reverse osmosis (RO) reject capillary	23	Storage tank (25, 50 or 100L)
8	RO pump feed pressure sensor	24	Tank vent filter
9	RO recovery loop	25	ech ₂ o® ASM lamp
10	Flow controller	26	Distribution inlet solenoid valve
11	RO flush solenoid valve	27	Recirculation loop
12	RO pump	28	Distribution pump
13	Feed conductivity cell	29	Primary E-POD® unit (mandatory)
14	RO pressure sensor	30	Secondary E-POD® unit (optional)
15	Thermistor	31	Application POD-Pak
16	RO membrane (1 or 2 depends on syst type)	32	Flowmeter

This system uses potable tap water as feed and produces pure (Type 2) delivered by 1 or 2 independent E-POD® unit(s).

The system is divided into three sections. These are the production, the storage and the distribution.

Production: Tap water is first purified by the IPAK Gard® pretreatment pack which contains the pleated filter and carbon block. Particles, colloids and free chlorine are efficiently removed before the reverse osmosis purification. The intelligent reverse osmosis (RO) purification that controls water consumption, ensures a constant product flow rate and optimal water quality. A large percentage of contaminants are removed at this stage such as the ions, particles, bacteria and large organics. The purified RO water then enters the patented electrodeionization (EDI) module, where ion-exchange resins are continuously regenerated by a small electrical field. The pure water then passes through the mercury-free ech₂o bactericidal lamp where bacteria is further eliminated resulting in pure (type 2) water then stored in the storage tank.

Storage and distribution: Pure water is stored in high-quality polyethylene tank, which is equipped with a vent filter and the mercury-free ech₂o® automated sanitization module (ASM) lamp. The tank vent filter maintains the consistent purity of stored water and provides effective protection against airborne contaminants. The ech₂o® ASM lamp further protects the integrity of the stored water with regular exposure to bactericidal UV light. Throughout the distribution, resistivity, temperature and pressure are monitored. Tank is configured with 2 or 5 meters connectors to the main production unit depending on the laboratory setting.

The E-POD®(s) unit(s) is/are the main interface(s) with the user. They are configured with 2 or 5 meter connectors to the main production unit depending on the laboratory setting. The arm holding the dispenser on the mast can be moved up/down, right/left and can be unhooked to adapt to laboratory glassware. Its dispensing 'wheel' delivers water from low flow up to 2 L/min flowrate. The E-POD® unit large 5" touchscreen offers a wide range of applications for users. It also has an USB port to easily export data. At the outlet of the dispenser, the final purification is performed by the application-specific POD-Pak (recommended).

When not in active use, the water within the units will recirculate for three minutes every hour. This is to maintain water quality and to avoid contamination. The system should not be turned off as this will stop the periodic recirculation taking place.

QUICK START

Navigate the screen interface

HOME SCREEN

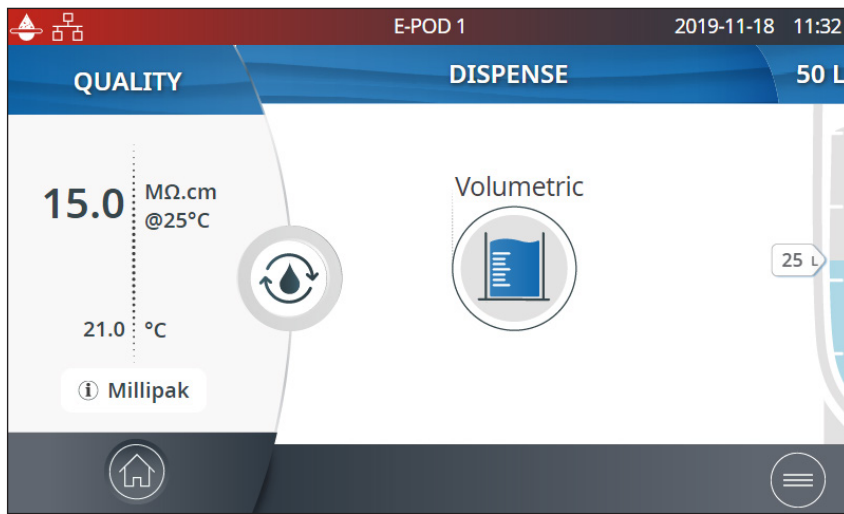

Home

- Water quality information
- Dispensing functions
- Alerts & Alarms (when generated by the system)
- Dispense report (when generated by the system)



MAIN MENU

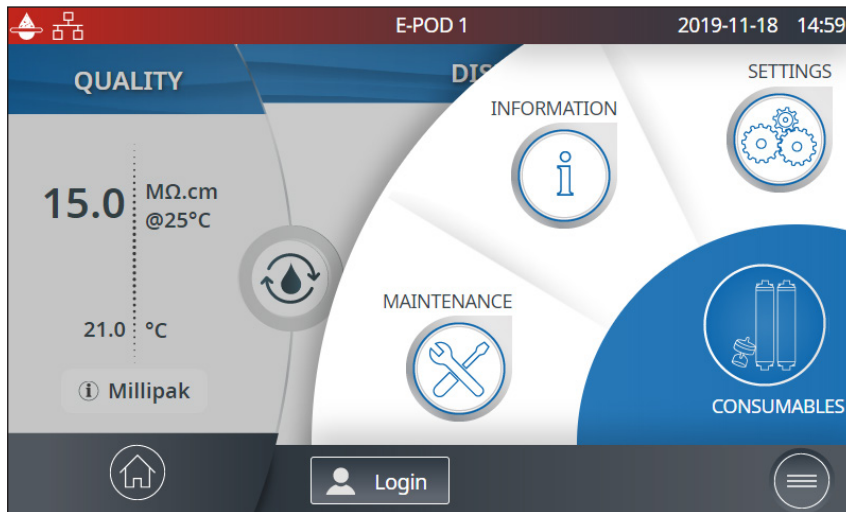

Menu

- Consumables
- Information
- Settings
- Maintenance
- Login

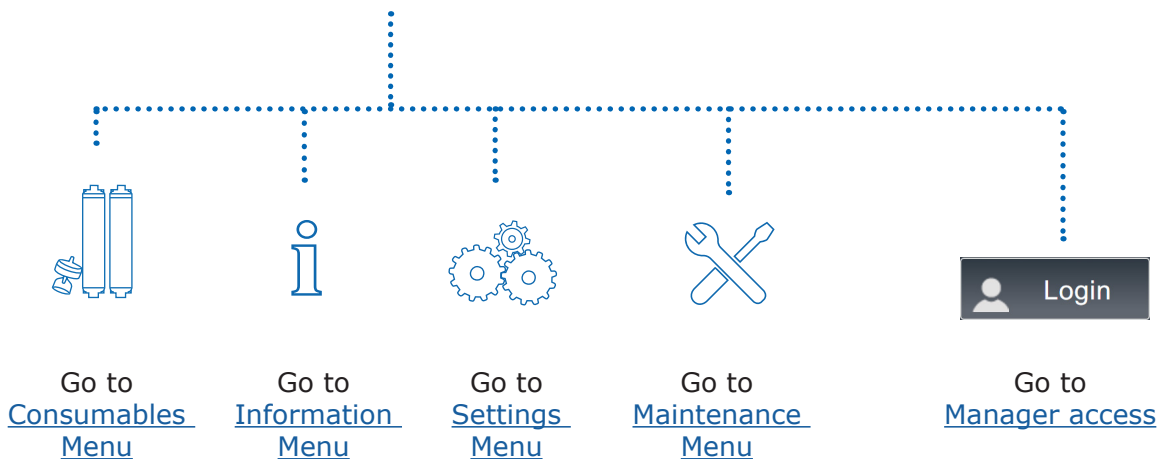

Apps

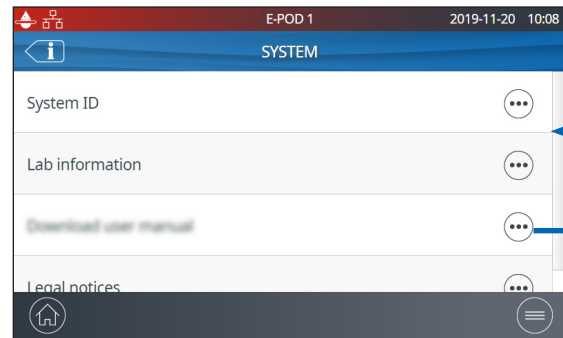

When there are multiple lines, a scroll bar is present to swipe up & down



Indicates how many screens are present and where you are.

Swipe left & right anywhere on screen to switch between screens.



Pops-up

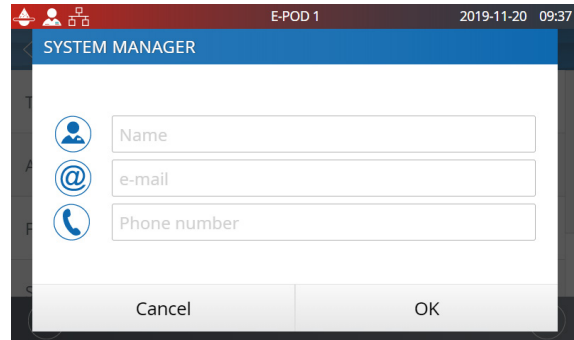
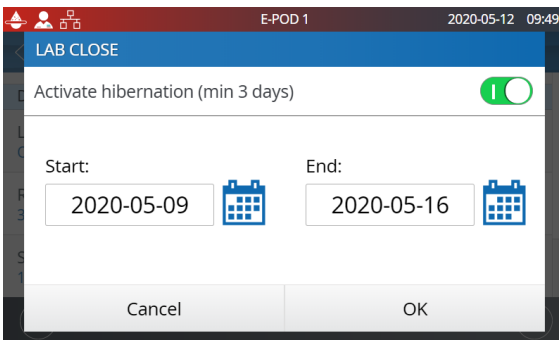

When a text box is selected, the keypad will automatically appear.

To remove the keypad click on  or on any zone outside the keypad.



Note: When in a menu or app level screen, 1 minute of inactivity generates a time-out back to the home screen.

When in a pop-up level screen, there is no time-out, therefore the user remains on this screen until the pop-up is manually closed.

Important! If multiple E-POD® units are installed and a pop-up in the settings or maintenance menus is not closed, dispensing will remain unavailable on all E-POD® units until the pop-up is manually closed.

Dispense pure water

Before dispensing pure water

It is a good practice to always recirculate water before dispensing. The recirculation lasts 3 minutes and is triggered every 60 minutes.

To do this, press on the recirculation icon .

When connected to a storage tank, always make sure there is enough water present before dispensing. This information is always displayed on the maexin screen.

Dispensing pure water in free flow mode

There are several options to dispense pure water:

Manual Dispensing

To start low flow dispensing, turn the dispense wheel one notch counter-clockwise.

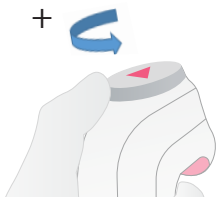

Adjust flow rate

To increase the flow rate, keep turning the wheel counter-clockwise until full flow is reached. To decrease the flow rate, turn the wheel clockwise.

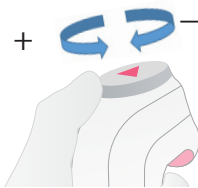

Full flow

To start dispensing in full flow, press the wheel once and quickly release.

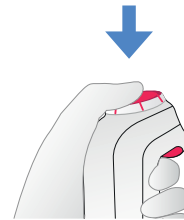

Stop

To stop any ongoing dispensing, press down on the wheel one additional time or rotate the wheel clockwise until no more water flows from the dispenser.



Dispensing pure water in volumetric dispensing mode

Enables a user to auto dispense a pre-selected volume (20mL to 100L, depending upon the tank capacity). Simply press the icon  of the Home screen to start a volumetric dispensing.

1- Press the pre-selected volume box to set the desired volume to dispense. If the volume is already ok, either press the start button on the screen or the dispensing wheel to initiate the dispense.

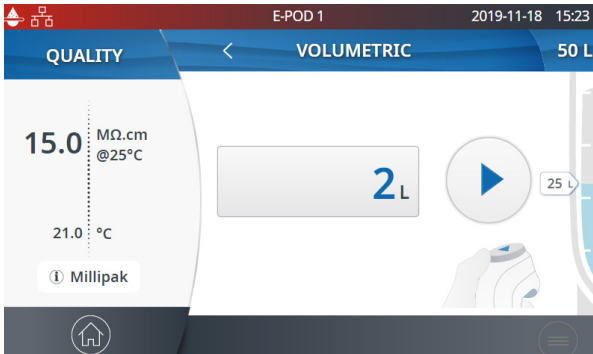

2- Select the unit.

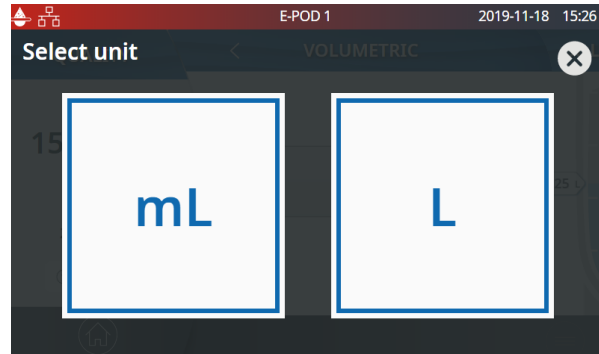

3- Select the desired volume and press OK to validate.

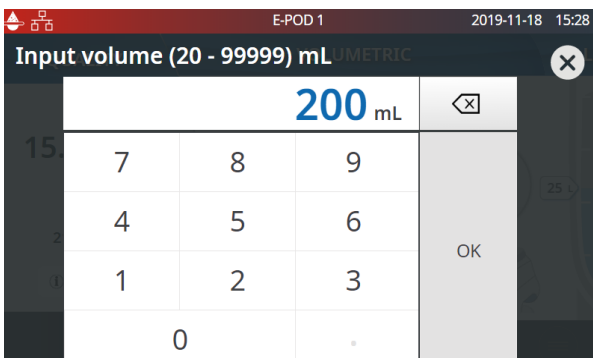

4- Press the start button on the screen, the dispense wheel or the foot pedal to start dispensing

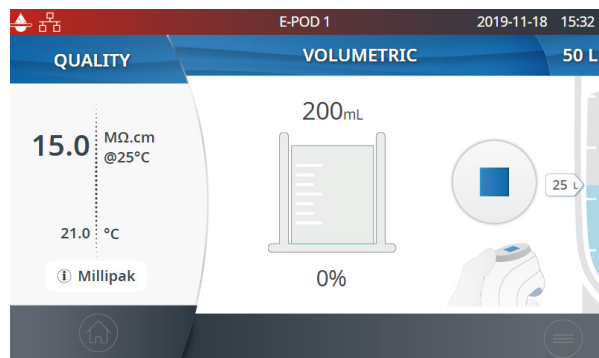

5- The system will automatically stop once the input volume is dispensed. Either press the stop button on the screen, the dispense wheel or the foot pedal to stop dispensing

Note: The system records the last volume dispensed. To repeat a volumetric dispense, click on the start icon, press the foot pedal or press the dispensing wheel.

Manage dispense reports

A dispense report is automatically produced after each dispensing operation. A dispensing operation is considered to be all dispenses with less than 10 second intervals between them. This can be interrupted at any time by pressing on the dispense report icon that becomes available on the home screen as soon as a dispensing is initiated.

1. Consult the report data

Click on the dispense report icon:

Dispense
report

2. Personalize (assign a name or experiment number)

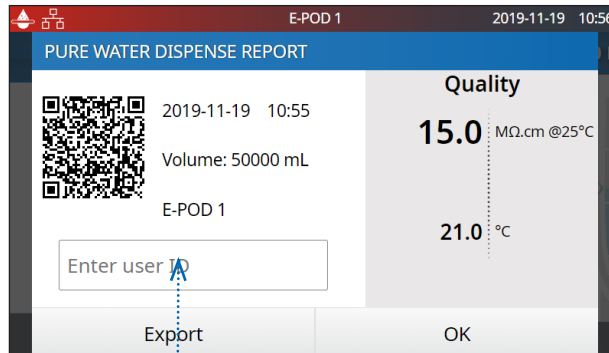

In the user ID field, enter the content of your choice (max 15 characters)

3. Export

- Scan the QR code® from a mobile device to instantly retrieve the report.
- Click on the export button to save the report on a USB key.

4. Automatic archiving

The dispense report icon on the home screen will automatically disappear after 5 minutes of inactivity. Each dispense report, whether consulted or not, is automatically archived and can be retrieved anytime by going in the history report section available in the information menu. Go to page 14 [Information > History](#) for further information.

Exit screensaver

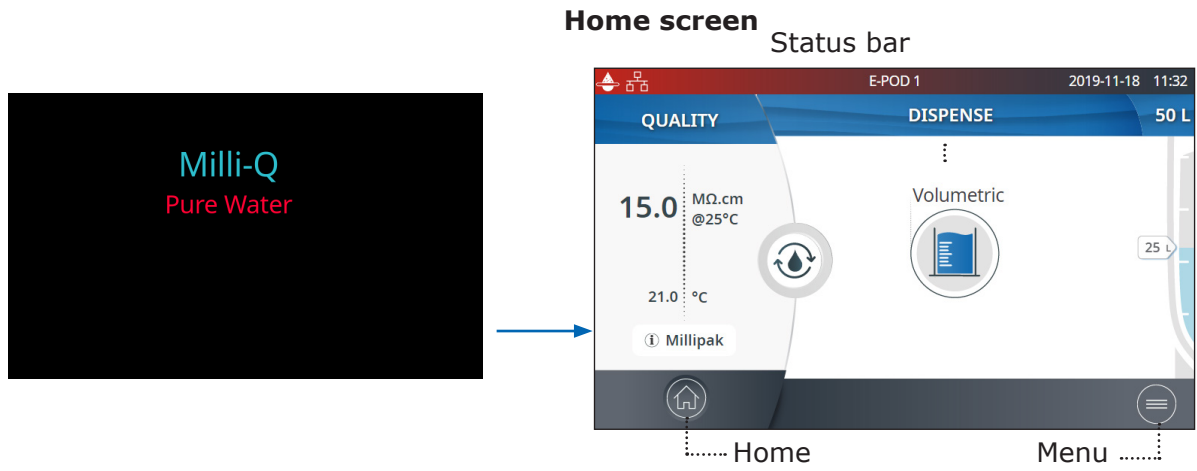

If the setting is active and there has been a certain time of user inactivity, the screensaver will be displayed on the E-POD® touch-screen.

Tap anywhere on the screen or initiate a manual dispense by pressing the dispenser wheel to exit the screensaver.



View & manage Alerts and Alarms

Alerts give you advanced warning when maintenance is required and Alarms notify you when the system has encountered a technical issue.

Press on the alert  or the alarm  icon present in the bottom bar to display the alert(s) or/and alarm(s) which are active.

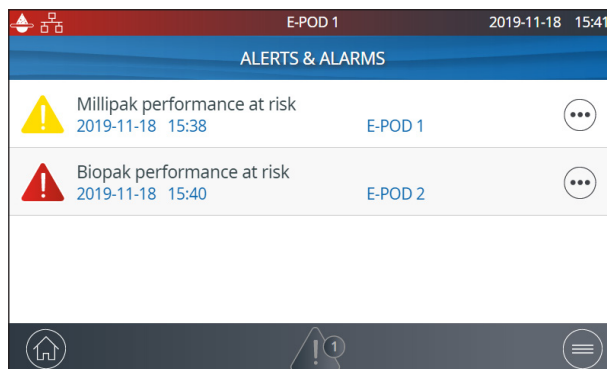

Note: The notification number indicates how many active alarms are present. When there are no active alerts or alarms, the relevant icon disappears.

Select a specific alert or alarm to get further information and better understand the root cause. Advice is provided in the information section to help the user troubleshoot.

If the issue is not resolved and depending upon the alert and alarm, either select the **Contact** tab to find the technical support hotline number for further assistance or the **Order** tab containing ordering information when applicable.

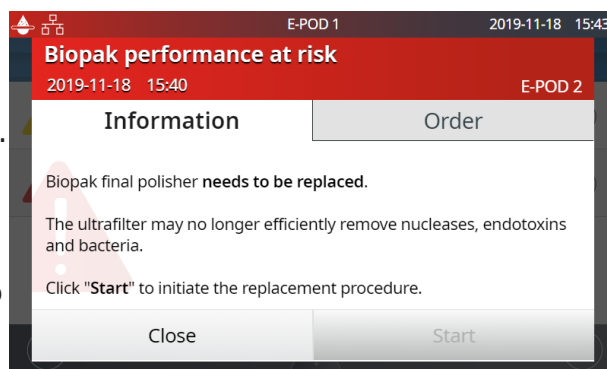

To protect the system and user applications, alarms of a serious nature will automatically stop the system from dispensing water.

Note: These are displayed on the screensaver to tell the user when the system is not in active use.

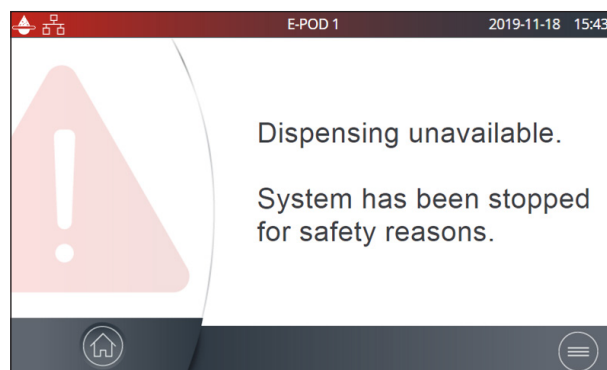

Alerts provide advanced warning of any maintenance actions that will be required. These can be "closed" to be reminded again in 24h or can be "cleared" permanently.

An **Order** tab can also be present when applicable.

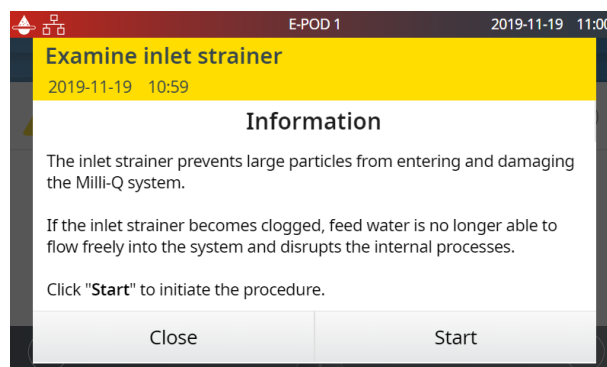

CONSUMABLE MENU

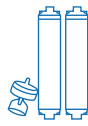

View consumables status

Colour icons allow to instantly view the status of all installed consumables.

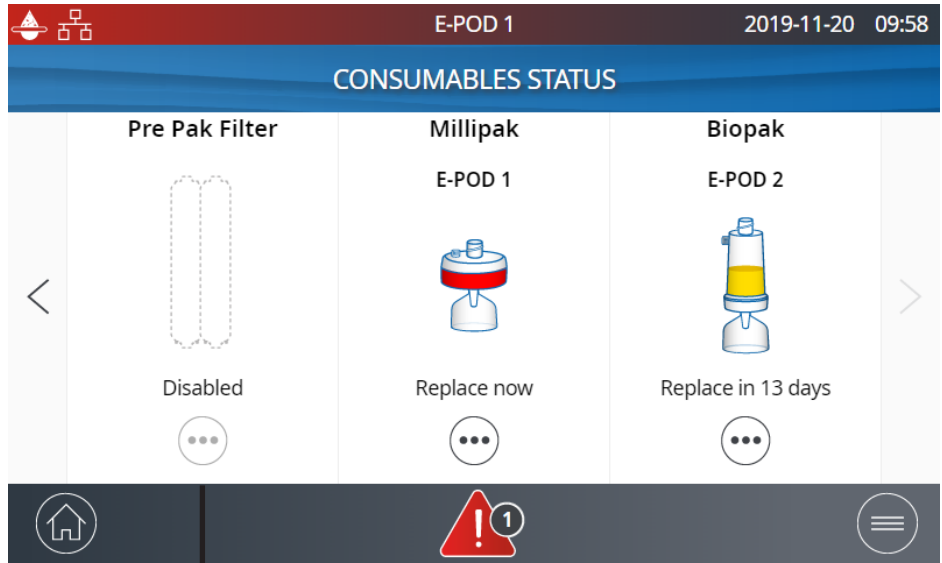

- Green: no action required
- Yellow: notice for a maintenance action
- Red: maintenance required!

Press on the icon to get the consumable ID, ordering information and a description of the purification technology.

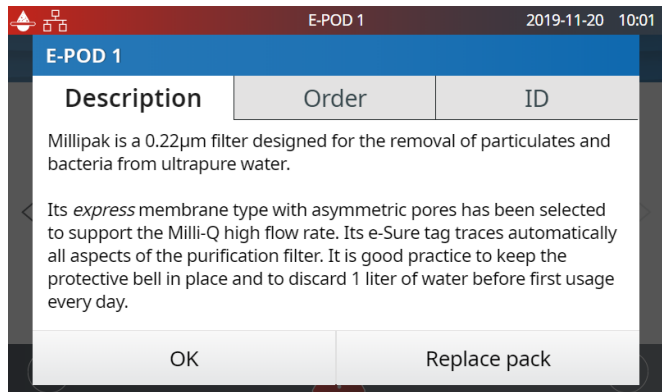

Note: Certificates of quality are now available online www.mymilliqconsumables.com

All cartridges have been designed to be easily replaced by a user. A short-cut is available to the replacement wizard by clicking on the "replace pack" button in the pop-up.

Important! Mercury-free $\text{ech}_2\text{o}^\circledR$ UV lamps should not be replaced by users. Contact the technical support hotline to organize a replacement visit.

Consumables identification with card reading

For each consumable, the following pieces of information are available:

- lot number
- catalog number
- installation date

The IPAK Gard® and application POD-paks information is automatically registered during their installation.



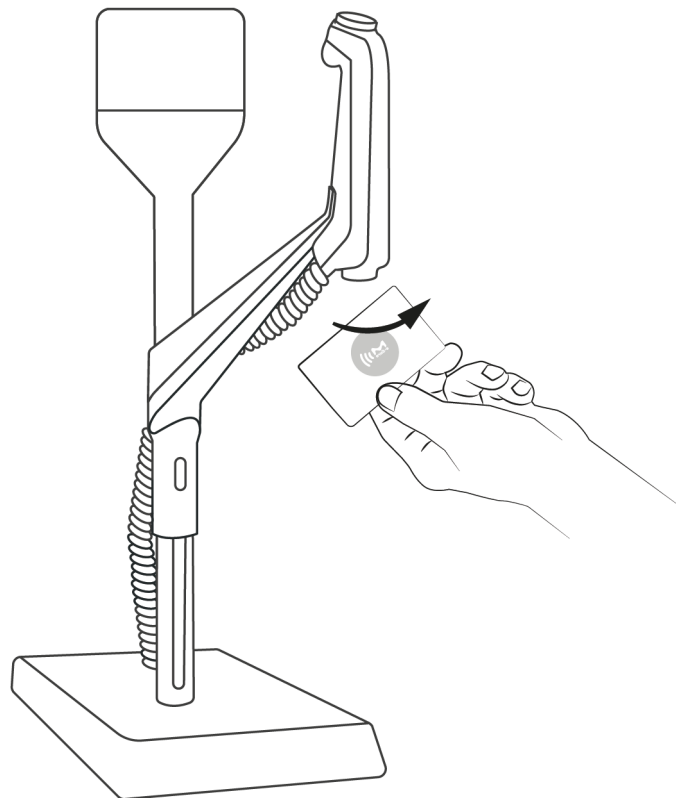

The tank vent filter comes with a RFID card enabling the transfer of the data into the system. Go to page 29 [Maintenance>Consumables installation wizard](#) for further information.



INFORMATION MENU

This menu contains useful system information and provides a system status. Dispensing is available while in this menu.

Available apps:

 System	 History	 Troubleshooting
 Contacts	 Flow schematic	

System

Find system details

Select *System ID* to find the information on the water system model and installation details.

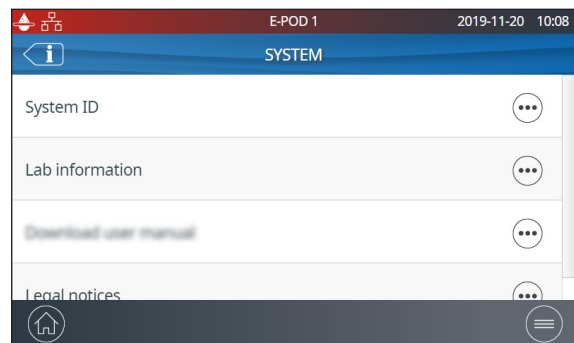

History

2 user reports exist:

- [Daily quality measures report](#)
Each row represents a day (24h) and is dated. It contains daily averages for product resistivity and temperature. Also included is the total volume dispensed during the day.
- [Dispensing events report](#)
Each row is a dispense operation. It is an archive of all the dispense reports.

To export data or preview a graph:

1. Select a time period of interest with a start and end date.
2. A graph pre-view of the last 30 records is available on the E-POD® screen.
3. Export the report in .ods (open document source) format to visualize the full data and integrate them into a data management system.

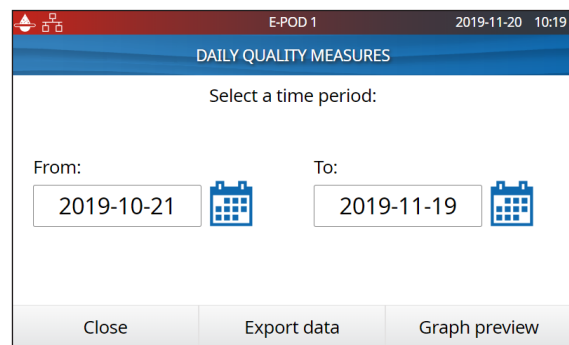

Note: A complete history report with all system activity is available. By default it is only available when logged-in as the system manager. This can be modified by de-activating the system manager profile in the settings menu, go to page 19 [Settings>Manager access](#).

Flow schematic

This is a graphic representation of the hydraulic components of the water purification system. Components change colour depending on the state and system status.

Grey - inactive Blue - active
Yellow - maintenance alert Red - technical issue alarm

Production flow schematic

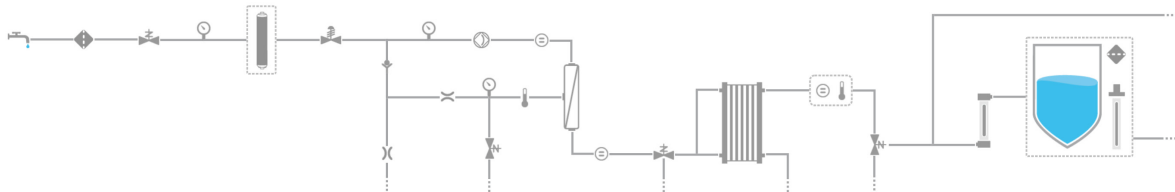

Distribution flow schematic

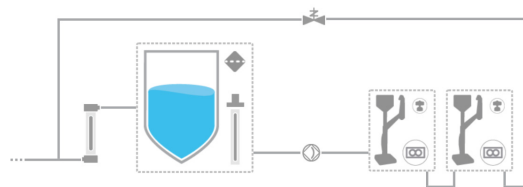

Troubleshooting

Access a diagnostic summary.

This app contains all the necessary information in one location for effective troubleshooting when in contact with the technical support hotline.

- System information & last service visit
- Water quality & consumables (installed dates)
- Active alerts, alarms & auto-test results
- Diagnostics

Contacts

To edit contact information, login as the system manager, go to page 19 [Settings>Manager access](#). The user parameters are used on various reports generated by the system and can quickly help users identify the right contact for any questions or issues.







Technical support hotline	In case of troubleshooting
Application specialist	Application enquiries or quote requirements
Field service engineer	<i>Only in selected countries, contact technical support</i>
System manager	Responsible for system configuration & quality settings
Maintenance operator	Responsible for maintaining the system

SETTINGS MENU



Different settings are available to customize the water purification system operation. Depending on the user profile (end-user operator / system manager) some of the settings will have either read-only or read & write access.

Available apps:

 System Configuration	 POD Configuration	 Date, Time & Language	 Password
 Alarm Configuration	 Connectivity	 Units	

Note: Dispensing while in this menu is not available.

Settings		End-user	System Manager
General system Configuration	Screen saver	Read only	✓
	Water sensor	Read only	✓
	Alarm relay	Read only	✓
Production configuration	Periodic EDI rinsing check time	Read only	✓
	Periodic EDI rinsing duration	Read only	Read only
	Periodic EDI rinsing period	Read only	Read only
Tank configuration	Tank capacity	Read only	Read only
	Tank refill setpoint	Read only	✓
	ech2o® ASM lamp cycle start hour	Read only	✓
Distribution configuration	Lab close	✓	✓
	Recirculation Duration	Read only	Read only
	Safety flow stop	Read only	✓
Production alarm configuration	EDI resistivity	Read only	✓
	Permeate conductivity	Read only	✓
	RO ionic rejection	Read only	✓
	RO feed conductivity RO high	Read only	✓
	RO feed conductivity tap high	Read only	✓
	Inlet strainer clean	Read only	✓
	Cl ₂ clean	Read only	✓
	IPAK Gard lifetime		✓
IPAK Gard volume		✓	
Tank alarm configuration	Vent Filter		✓
	Tank empty	Read only	✓

Settings		End-user	System Manager
Distribution alarm configuration	Millipak®		✓
	Millipak® Gold		✓
Connectivity	Local network	Read only	✓
	Wi-Fi configuration	Read only	Deactivation only
Date, Time & Language	Time zone - Date - Time	Read only	✓
	Select language	Read only	✓
Password	System manager		✓
Units	Resistivity / Conductivity	Read only	✓
	Temperature	Read only	✓
	Storage tank	Read only	✓
	Temperature compensation mode	Read only	✓
	Pressure	Read only	✓

Manager access (& password)

Login as a Manager

1. Press on the menu button  from the Home page.

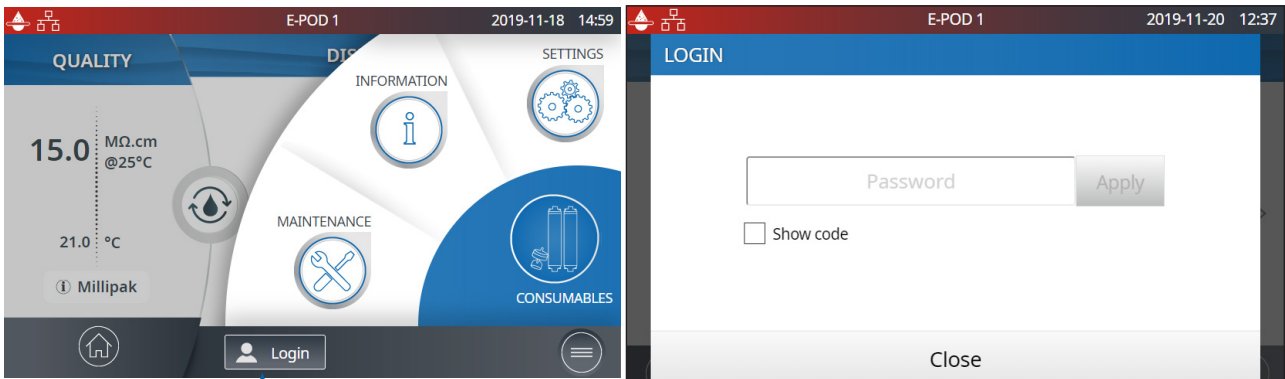

2. Press on *Login*.
3. Enter system manager password.

To display & see the password while typing, check the Show code box Show code

Once logged-in, the manager icon  is displayed in the top left corner.

If a manual logout is not performed, the system manager profile will be automatically logged out after 1 hour of no activity.

Note: By default this parameter is activated. The default password is **PASS**
If the system manager password is forgotten, contact the technical support hotline.

Log off as a Manager

1. Press on the menu button .
2. Press on "Logout".

Modify system manager settings

This can only be done when logged-in as a manager.
In the **Password** app:

1. Deactivate/re-activate the manager password through the password activation slider button.
2. If required, change the password.

Important! Deactivating the system manager profile will enable all settings to be modifiable by any user.

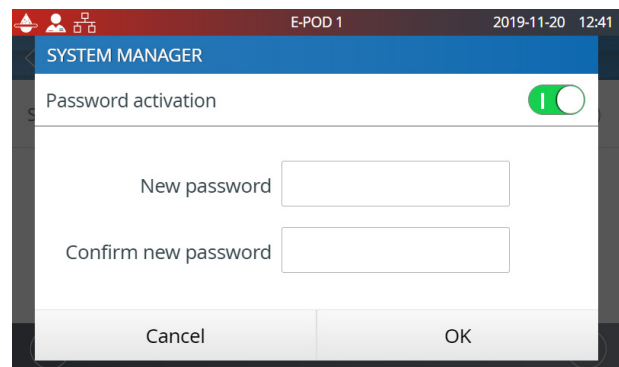

System configuration

Lab close

When leaving the lab for long periods of inactivity, this mode can be activated to save energy and reduce wear of system components. Recirculation is reduced to once a day. 24h prior to resuming lab activity, the system automatically resumes a recirculation every hour, ensuring it is ready for use.

1. Activate Lab close via the slider button.
2. Enter a Start and End date (minimum of 3 days). Lab close mode will be initiated at 00:01 on the selected date.

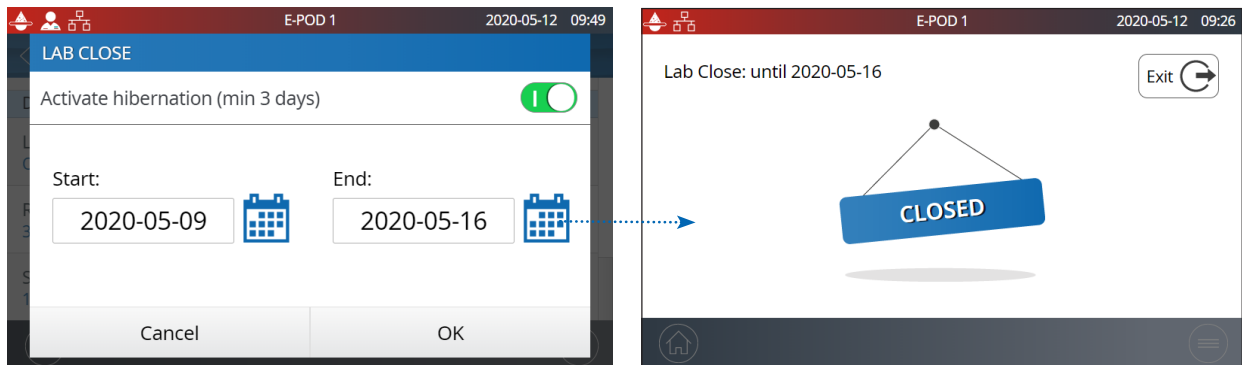

Safety flow stop

A precautionary measure that stops a E-POD® unit dispensing after having continuously delivered water for a certain duration.

Adjust to the preferred time by using the arrows or click on the box to access the keypad.

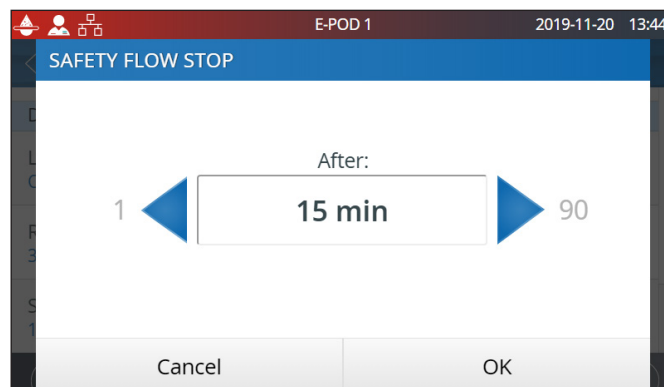

This setting will not impact volumetric dispensing functions.

Screensaver

This is the maximum duration of inactivity on a E-POD® unit before the screensaver starts.

1. Activate / deactivate via the slider button.
2. Adjust to the preferred time by using the arrows or click on the box to access the keypad.

This setting applies both to the primary and secondary connected E-POD® units (if applicable). By default the screensaver is active and the timer is set to 5 minutes.

Production configuration

The system includes a periodic EDI rinsing feature to ensure a good system performance and water quality is always maintained.

The rinsing will take place at the time of the day set in *Periodic EDI rinsing check time*, that can be chosen by the system manager to better adapt to the work time schedule.

The system will rinse the EDI for the *Periodic EDI rinsing duration* (1h by default) whenever the system did not produce Elix water for at least 1 hour during the time period set in the *Periodic EDI rinsing period* (24h by default).

E-POD® unit configuration

This app allows a user to configure all parameters specific to E-POD® units. These are unique to the E-POD® unit that is being used to input the values.

To duplicate the primary E-POD® unit parameters, the action(s) should be repeated on the secondary E-POD® unit.

E-POD® unit name

This can be personalized. Click on the text box and input up to a maximum of 8 characters.

Screen brightness

Adjust to the preferred brightness from 1 to 7 using the arrows or click on the box to access the keypad and type-in the value.





Sound volume

Each E-POD® unit can emit a sound when alerts/alarms are triggered. This can be activated or deactivated using the slider button. The sound can be adjusted to the desired volume by using the arrows or click on the box to access the keypad and type-in the value. By default, the sound is deactivated.

Flowmeter offset

The flowmeter has been calibrated in order to achieve volume precision of +/- 5%. Laboratory glassware accuracy can vary a lot. This setting provides a user with the ability to adapt the flowmeter to their current glassware accuracy by using an offset function.

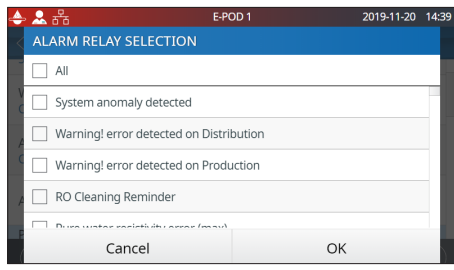
Adjust the offset by using the arrows or click on the box to access the keypad and type in the value. To gain back the original calibration settings, set the value back to 0.

Accessories	
<p>Water sensor</p> <p>A water sensor can be connected to the system unit to stop the system from producing water in case of water spillage. Up to 3 sensors can be connected in series to cover a wider surface area.</p>	
<p>Foot pedal</p> <p>The pedal is connected to the base of the E-POD® unit. In the E-POD® configuration app, activate the foot pedal via the slider button.</p> <p>Dispense using the foot pedal:</p> <ol style="list-style-type: none"> 1. Press once and release to dispense in full flow. 2. Press and hold to start dispensing in low flow, keep pressing to increase the flow rate until full flow is reached. Release at the chosen flow rate. 3. Press one additional time when you wish to stop the dispensing. <p>Note: The foot pedal may also be used to dispense water using the volumetric dispensing mode.</p>	
<p>Washer Distribution kit</p> <p>This accessory will allow distributing water from a storage tank to washing machines. It can be wall-mounted</p> <p>Note : A specific tank vent filter HF, has to be used for such high flow rate application.</p>	
<p>Alarm relay</p> <p>This accessory will allow to relay all, or a selection of alarms to a remote device. Select the alarm(s) that will activate the relay.</p> <p>Note : The Alarm relay selection setting appears in lab manager mode provided Alarm relay in ON.</p>	
<p>Sanitary sampling valve for storage and distribution loop</p> <p>The unique design of the sanitary sampling valve allows the user to sample mid-stream and prevents accumulation of bacteria or particles inside the sampling probe.</p> <p>It can also be sanitized effectively and easily in place.</p>	

Note: Please go to page 43 the [Requirements & Specification>Ordering information](#) to get the catalog numbers.

Alarm configuration

Adjust the alarm set points by either clicking on the arrows or alternatively, click in the box to access the keypad and directly type-in the value.

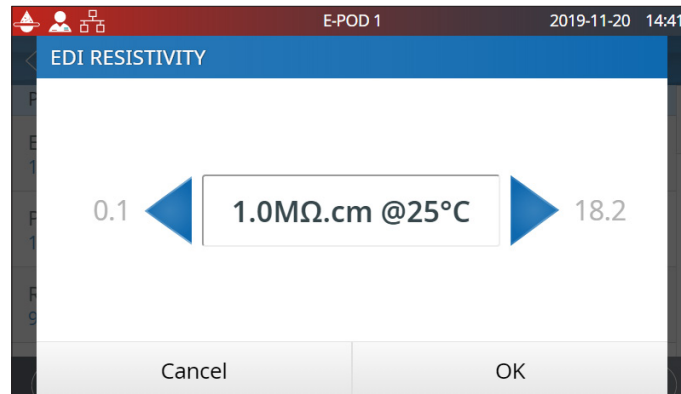

Alarm and unit	By-default value	Adjustable range
EDI resistivity (MΩ.cm @25°C)	1.0	0.1 - 18.2
(RO) Permeate conductivity (µS/cm @25°C)	100	1 - 250
RO ionic rejection (%)	92.0	0 - 99.9
RO feed conductivity RO high (µS/cm @25°C)	3400	1 - 4000
RO feed conductivity tap high (µS/cm @25°C)	2000	1 - 2000
Inlet strainer clean (days)	365	1 - 999
Cl ₂ clean (days)	90	1 - 365
IPAK Gard® (cartridge) (days)	365	1 - 365
IPAK Gard® (cartridge) (L)	30000	27000-30000
(tank) Vent Filter (days)	365	1 - 365
Tank empty (%)	0	0 - 50
Millipak® (0.22µm filter) (days)	182	30 - 182
Millipak® Gold (0.22µm sterile filter) (days)	182	30 - 182

It is recommended to clean the inlet strainer once a year to avoid it becoming clogged. Depending on the feed water and its particle concentration, the inlet strainer clean frequency can be adapted.

Cartridges should be changed when the system alerts the user. Two thresholds can be triggered for the replacement of the IPAK Gard® cartridge. The first is the time of use, the second being is the volume of water.

Saturated pack content will start to let ion and organic contaminants through. This is called breakthrough and often starts with traces that cannot be detected by on-board monitoring. Some technologies will clog, creating a back pressure which can result in flowrate issues or pressure alarms in the system.

In validated settings, to adjust lifetimes according to existing SOPs, click on the applicable filters and adjust accordingly.

Connectivity

The system offers the possibility to be connected to a laptop with a fixed IP address or to your local network (DHCP protocol/fixed IP address) via an Ethernet port. The DHCP (Dynamic Host Configuration Protocol) is an "automatic configuration" of a device anytime it connects to an IP Network. This "automatic configuration" is called allocation. The system is automatically recognized and configured so that the networks resources can be used. Check with your local IT resources which type of connection is best suited to you.

Change network connection settings

1. For a direct connection, change the network settings if necessary (default IP address: 192.168.1.69).
2. For network connection, activate DHCP via the DHCP activation button.

Duplicate user interface in a browser

Once connected:

1. Go to your browser. For best browsing performance, Chrome® is recommended.
2. Enter the IP address of your system which can be found in the connectivity pop-up screen.

Note: The view from a laptop enables a user to view the E-POD® unit display remotely. Dispensing operations cannot be conducted remotely for safety reasons. In addition, any configuration settings related to the E-POD® (i.e. flowmeter offset) can not be made via a connected device such as a laptop, but must be done at the actual HMI screen.

Date Time & Language

Date

Calendar date representations are shown in the ISO® 8601 format "2018-11-06" [YYYY-MM-DD]. [YYYY] indicates a four-digit year. [MM] indicates a two-digit month of the year, 01 through 12. [DD] indicates a two-digit day of that month, 01 through 31.

Start by setting the year:

1. Click on the *month & year* title, this displays months and only the year as a title. Click again on the *year* title to display years.
2. Select the year, this then displays months.
3. Select the month, this then displays the days.
4. Finally select the day to confirm the date setting.

Time ZONE

1. Select the continental or oceanic zone you are in on the left. This updates the right-hand side with all the major cities within this time zone.
2. Select the appropriate city. If you have not found a city, make sure you are in the right time zone.

The Milli-Q® system is now configured to display current local time and automatically updates when daylight saving time applies.

Time

The time is set and displayed in a 24h clock format. A time of day is written in the 24-hour notation in the form hh:mm (for example 14:23), where hh (00 to 23) is the number of full hours that have passed since midnight, mm (00 to 59) is the number of full minutes that have passed since the last full hour.

Language

There are 9 languages available: Chinese / English / French / German / Italian / Spanish / Portuguese / Japanese / Russian

Units

Units can be formatted to local needs:

Resistivity / Conductivity	MΩ.cm	μS/cm
Temperature	°C	°F
Storage tank level	L	%
Pressure	Bar / kPa / psi	

Select and press on the unit of interest. The selected unit will appear in blue. Press "OK" to confirm selection and exit the pop-up.

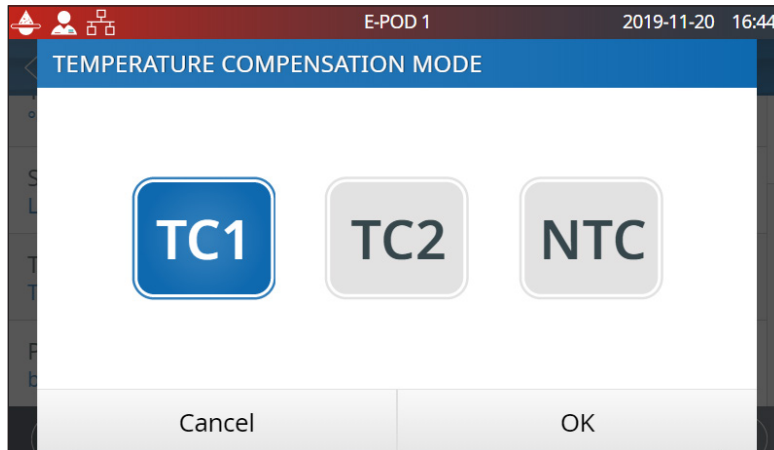

Temperature compensation mode

It is possible to show non-temperature compensated resistivity or non-temperature compensated conductivity. Temperature compensation is a way of standardizing resistivity or conductivity to measurements that would be seen if the water temperature was 25°C.

Select the preferred mode of temperature compensation:



TC1	<p>By default TC1 mode is selected.</p> <p>The resistivity or conductivity values are temperature compensated to 25°C. The values are normalised. The system firmware eliminates small fluctuations of temperature compensated resistivity or conductivity due to the fact that these two parameters are not measured exactly at the same time.</p>
TC2	<p>The actual temperature compensated resistivity or conductivity values are displayed. In some operating conditions the feed water can be warmer or cooler than the water temperature inside the system. As a result, this can cause small fluctuations of the resistivity and conductivity values. Resistivity values could fluctuate for pure water between <i>14.8 MΩ.cm and 15.2 Mohms.cm @25°C</i> while the actual resistivity is <i>15 MΩ.cm @25°C</i>.</p>
NTC	<p>Non Temperature Compensation. The temperature compensation is off. The displayed resistivity or conductivity is not temperature compensated. The temperature of the water is shown at the same time as the non-temperature compensated resistivity or conductivity value.</p>

MAINTENANCE MENU



The maintenance of the system is easy thanks to the step-by-step instructions contained in the wizards. In addition, a new IPAK Gard® cartridge design means that pack removal and installation in the system unit is quick and effortless.

Available apps:

 Install consumables	 Care/cleaning
 Depressurization	

Note: Dispensing in this menu is only available in the applicable wizards.

Maintenance screens

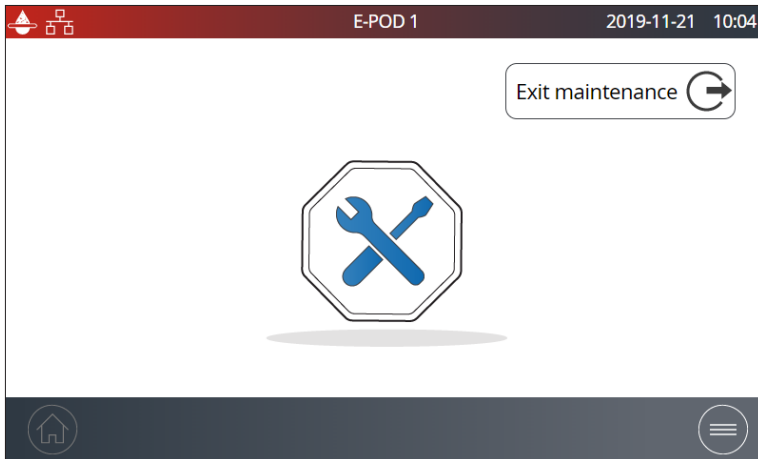

Maintenance ongoing from the current facing E-POD® unit.

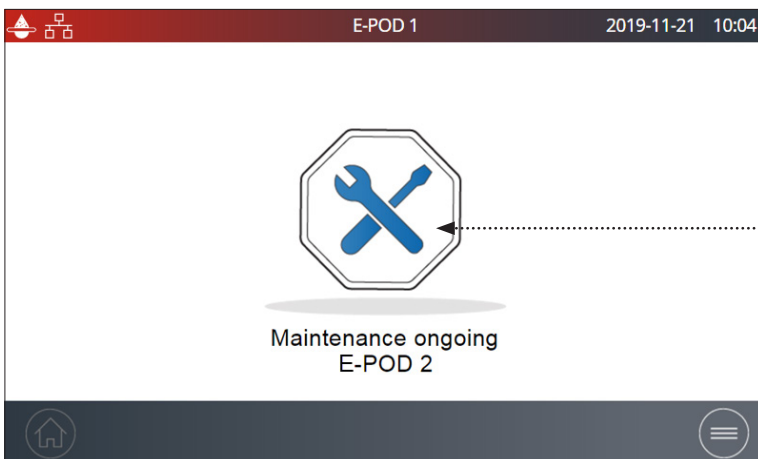

Note: To unlock both E-POD® units from maintenance mode and regain access to dispensing functions, click on "Exit maintenance".



Maintenance ongoing from another E-POD® unit or from a remote location if "External" is indicated on the screen.

Consumable installation wizards

A maintenance wizard can be accessed in different ways:

1. Through the Maintenance menu 
2. A shortcut from an Alert  or Alarm  pop-up
3. A shortcut from a consumable pop-up

IPAK Gard® replacement

1. Select the **Install consumables** app and click on *IPAK Gard installation*.
2. Follow the self-guided wizard.

IPAK Gard® 3-5 pretreatment pack : IPAKGARA1
IPAK Gard® 10-15 pretreatment pack : IPAKGARA2

1 or 2 IPAK Gard® cartridges depending on system type

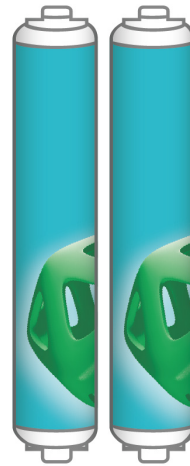

Note 1: When properly installed, the blue side should face you with the **e-Sure**  symbol behind.

Note 2: If the sound has been activated, it is normal to hear a buzzer when changing the consumables. This is temporary and is only present when the IPAK Gard® cartridge or POD-Paks are removed. As soon as they are put back into place, the buzzer will stop.

IPAK Gard® replacement sequence:

To remove the IPAK-Gard® cartridge(s), press on the button, rotate and pull. For the installation of a new cartridge remove the protective foils (at each cartridge ends) and twist until the click as described in the self guided wizard.

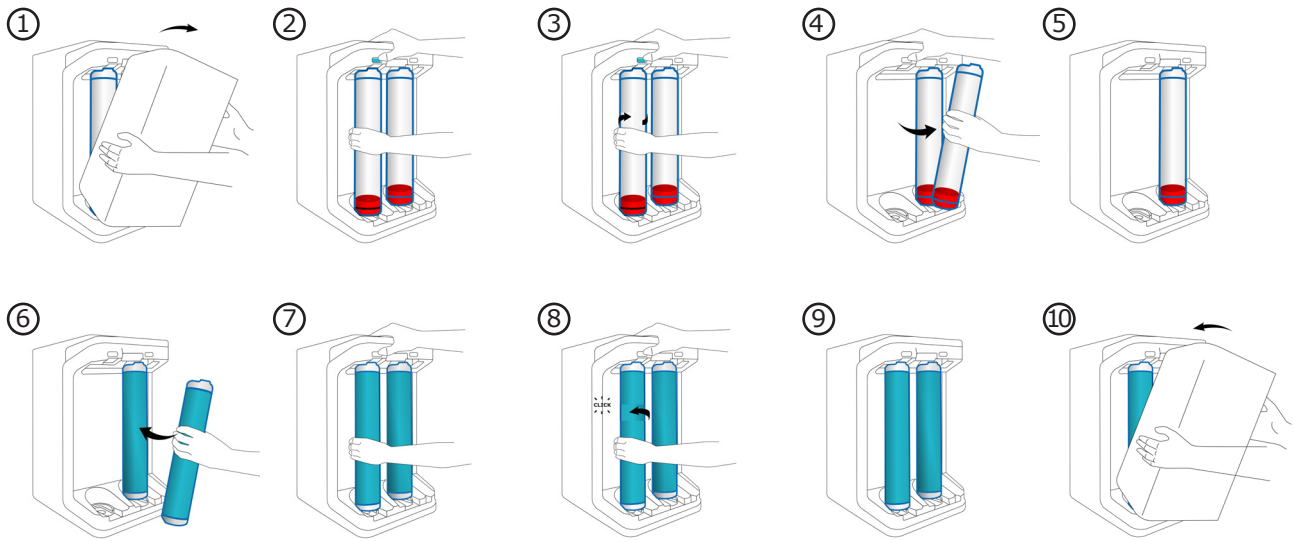

Note :

- Each Milli-Q® IX 7010/7015 systems has two IPAK Gard® cartridges whereas each Milli-Q® IX 7003/7005 systems has one IPAK Gard® cartridge.
- It is recommended to replace the tank vent filter when replacing the IPAK Gard® cartridges.

Application POD-Pak installation

1. Select **Install consumables** app and click on *Application POD-Pak installation*.
2. Select the POD-Pak to be installed, click on the *Next* button and follow the self-guided wizard.

Do not over tighten the twist & lock action when installing a new POD-Pak.

3. Rinsing must be performed manually to complete the installation as indicated on the screen. When completed press "Finish" to exit the wizard.

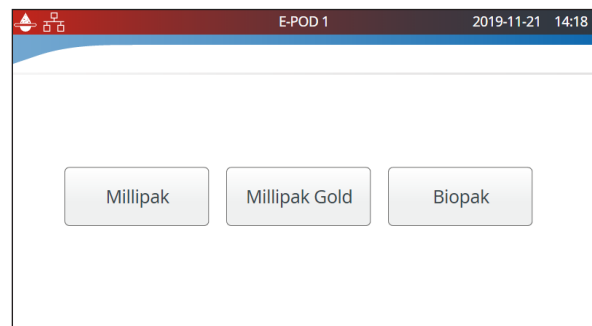

Note: All certificates of quality are now available online.

Visit www.mymilliqconsumables.com

Storage tank vent filter replacement

The vent filter located at the top of the storage tank can easily be removed and replaced as described below. When ordered, it comes with a RFID card for the details registration.

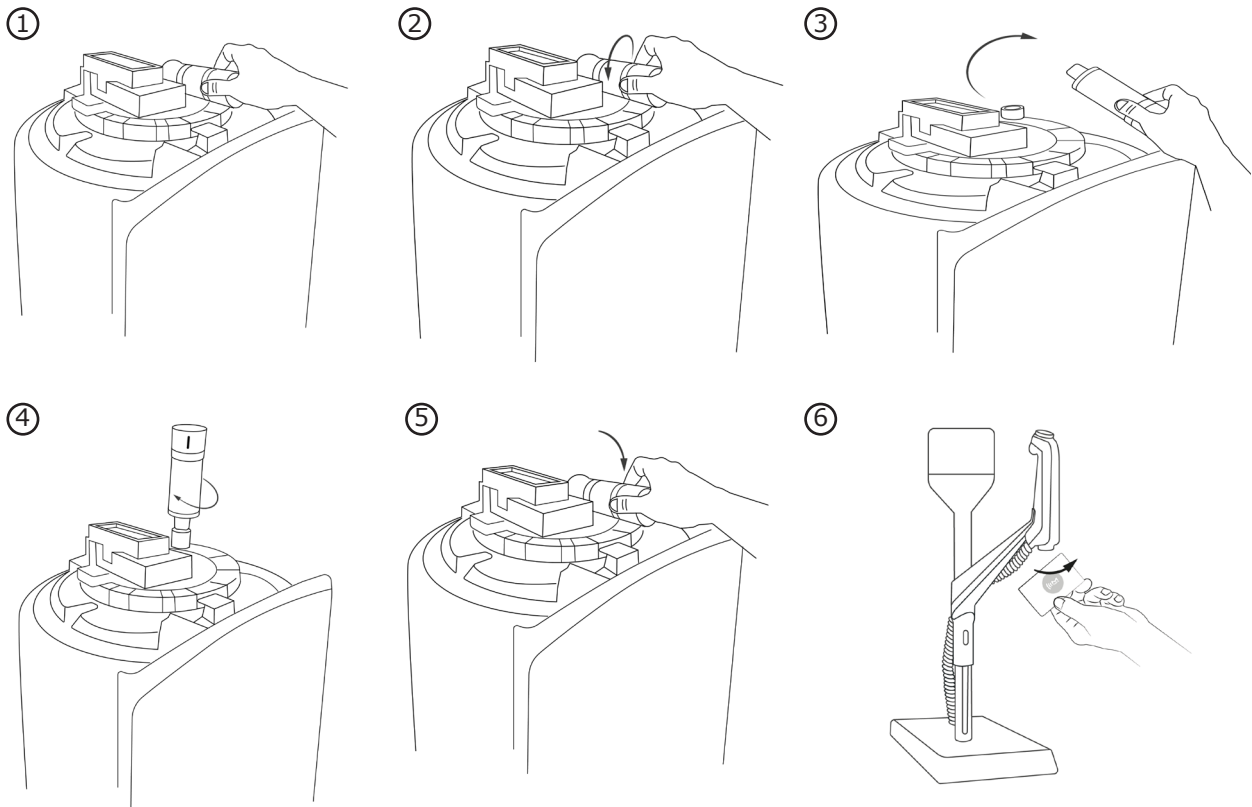

Important! The tank lid should remain locked. Never try to lift it due to the presence of the ASM UVc LED.

You can register the vent filter details by selecting the *Install consumables* app and selecting the vent filter”:

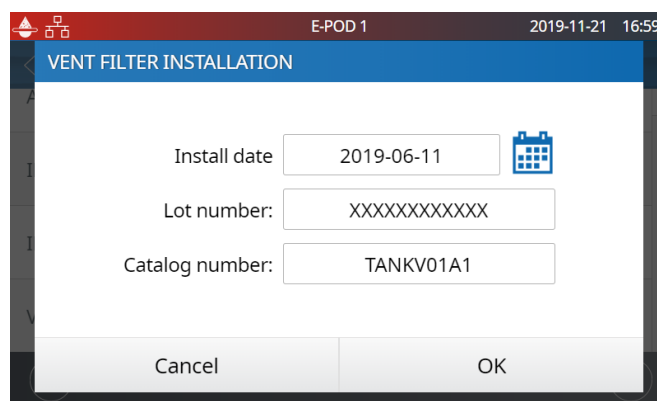

You can either manually type in or register the data by scanning the RFID card on the e-Sure tag reader located on the handle of the E-POD® dispenser unit. If you manually type in the data, replace “XXXXXXXXXXXX” by the actual lot number of the vent filter. You can find the lot number written on the label of the box.

Cleaning & Sanitization

Cleaning the inlet strainer

The purpose of the inlet strainer is to prevent large particles from entering the Milli-Q® system. If the inlet strainer becomes clogged, then feed water does not flow freely to the system.

Select the **Care/Cleaning** app and click on *Inlet strainer clean*. Follow the self-guided wizards.

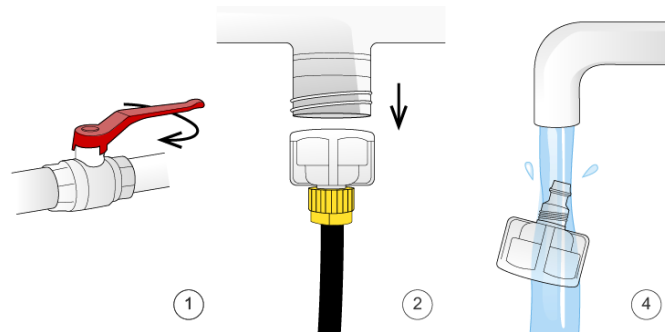

Cl₂ Cleaning

Follow the self guided wizard. The accessories holder can be used to store the ROProtect C and the sanitization port tool. Contact your service representative for further information. We recommend performing the Cl₂ cleaning every 90 days.

pH Cleaning

Follow the self guided wizard. Contact your service representative for further information.

Cleaning the external surfaces

For cleaning and disinfecting the external surfaces of the equipment, use a lint-free cloth wet with one of the following disinfecting agents:

- KLERCID™ Isopropanol 70% or equivalent composition
- SPOR-KLENZ® (Ready to use) or equivalent composition

Note that applying any other agent on the surfaces can damage them.

ech₂o® UV lamps - mercury free

Contact the technical support hotline to organize a replacement visit.

It is highly recommended to have a qualified Milli-Q® field service representative to change the ech₂o® UV lamps. Replacement of the lamps involves removing the panels of the Milli-Q® system.



Hazardous UV light !
Hazard of irradiation can cause severe eyes injury.

Important! Never open the system, even when the power switch has been switched off.





It is not sufficient to switch off the system, the plug must be physically removed from its power source. Installation and maintenance should only be done by a qualified person. Appropriate personal protective equipment (PPE) must be worn and safe work practices must be followed.

Depressurization

Two features are available in the **Depressurization** app: the production depressurization and the distribution maintenance. Both features are not necessary during normal operation. Use them in case of water leak to temporarily stop tank filling and all water processes. Identify the source of the leak. Once fixed, don't forget to leave these modes.

Production depressurization

The production depressurization is available by selecting the **Depressurization** app.

Simply press  when  turns into  to keep using the system. This temporarily stops production and all water processes. To go back to tank full/tank filling, swipe down from the top of the touchscreen (near "E-POD 1") and press .



Depressurization of production part in progress

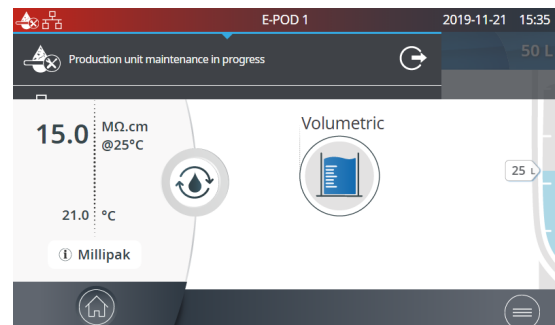

Distribution maintenance

The distribution maintenance is also available by selecting the **Depressurization** app.

Install the E-POD® unit near a sink and press the dispenser wheel to temporary disable the dispensing. Press the "Exit maintenance

 " button to enable the dispensing again.

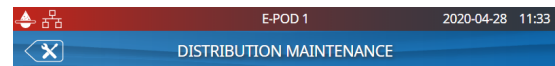

Maintenance: dispense unavailable

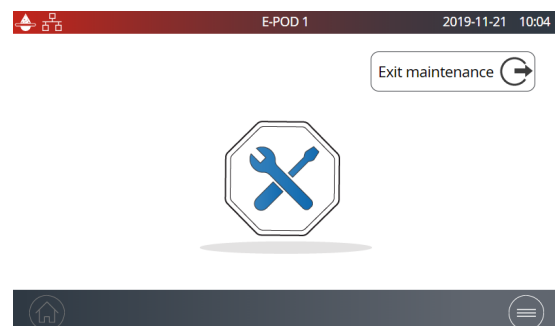

SELF HELP GUIDE

Troubleshooting tips

Turn system off

Press the ON/OFF switch located on the left side of the unit.

Note: When the system is on, the power switch is lit.

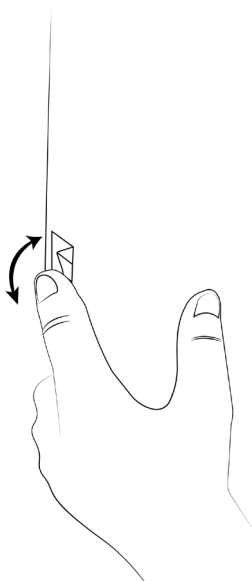

& UNPLUG

Important! Never open the system, even when the power switch has been switched off. Hazardous voltage is present with a hazard of electrical arc flash. Will cause death or serious injury.

It is not sufficient to stop all power to system, the plug must be physically removed from its power source. Installation and maintenance should only be done by a qualified person. Appropriate personal protective equipment (PPE) must be worn and safe work practices must be followed.

If the system is powered off for 20 days, the capacitor will completely discharge. When powering on again the system, the time & date settings will need to be reset, see page 24 [Information>Date Time & Language](#). It takes about 45 minutes to recharge the capacitor.

Inaccurate volumetric dispensing

Volumetric dispensing has been validated to work +/- 5% precision. Lab glassware precision can vary and to accommodate local needs a flow meter offset menu has been created. Go to page 21 [Settings>System configuration](#) for more information.

Low flowrate

- Ensure the POD-Pak is not air-locked. This can happen in the weeks that follow a replacement of IPAK cartridges. Dispense water and open the POD-Pak air vent to see if there is any trapped air. Close the vent once the air has been released.
- One possible reason for a decrease in Milli-Q® Water flowrate is a clogged POD-Pak. The POD-Pak should be replaced when it appears to be clogged.

Tank is not re-filled of pure water

- Open the drop down menu swiping down on the touchscreen to check the status of the pure production section.
- Exit the maintenance or rinsing mode in case it is activated.

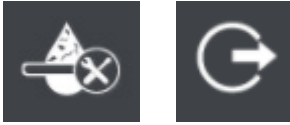

- Solve any alarms that could be stopping the production process.





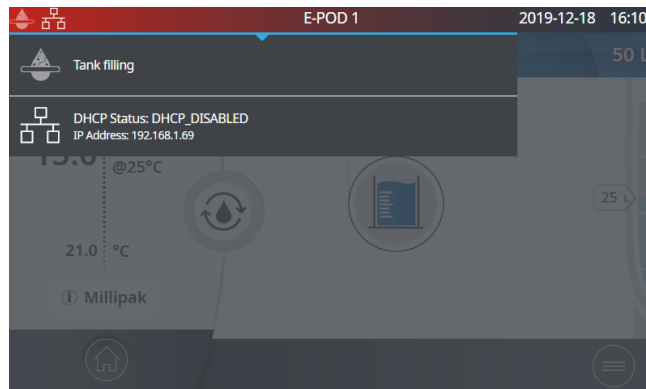









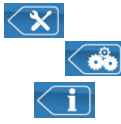









- At the end, make sure the  icon is present on the top left corner of the screen. A blinking icon indicates the tank is being filled. A solid icon indicates a full tank.



Contact us

If assistance is needed, then get in contact with a local technical service representative. The details can be found in the contacts app, go to page 16 [Information >Contacts](#) or visit our website www.sigmaaldrich.com

Icons

Icon	Meaning/Function	Icon	Meaning/Function
	Recirculation		Dispensing
	Volumetric dispensing		Back to maintenance, information or settings menu
	Start dispense		Stop dispense
	Alarm with number of active alarm(s)		Alert
	Home		Menu
	Storage tank		System manager logged in
	Mass storage USB connected		Ethernet - LAN status connected
	Slider ON		Slider OFF
	Back		Calendar entry
 (blinking)	Production Unit producing water	 (solid)	Production Unit standby
	Production Unit blocked		Production Unit maintenance
	Production Unit Maintenance exit		Distribution maintenance exit

REQUIREMENTS AND SPECIFICATIONS

Water specifications

Feed Water

The system has been designed to operate within feed water requirements:

Parameter	Value or range
Pressure	1 bar < P < 6 bar
Type of water	Potable tap water
Temperature	5 - 35°C (41 - 95°F)
Conductivity	< 2000 µS/cm @ 25° C
Dissolved CO ₂	< 30 ppm
Free Chlorine	< 3 ppm
Fouling Index	< 10
pH	4 < pH < 10
Maximum Total Organic Carbon (TOC)	< 2 ppm
LSI	< 0.3
Hardness as CaCO ₃	< 300 ppm
Silica	< 30 ppm
PrePak - maximum total chlorine level	3 ppm for PRPKF00A1
PrePak - maximum Fouling Index	18 for PRPKF00A1

Pure (Type 2) Water: Elix Water

The Milli-Q® IX 7003/7005/7010/7015 system is intended to produce pure water that meets or exceeds water quality specifications described by the organizations below:

Organization	Water quality / grade
European Pharmacopoeia	Purified water
U.S. Pharmacopoeia	Purified Water
Japanese Pharmacopoeia	Purified Water
Chinese Pharmacopoeia	Purified Water
ASTM® D1193	Type 2 water - Reagent water
ISO® 3696	Grade 2 water
Chinese National Standard	GB 6682 Grade 2 water

With respect to daily, freshly produced water, the Milli-Q® IX system is intended to dispense pure water that meets or exceeds water quality specifications described by the organizations below.

Parameter	Value or range
Resistivity	> 5 MΩ·cm @ 25°C typically 10–15 MΩ·cm
Conductivity	0.2 μS/cm; typically 0.1 μS/cm
Total Organic Carbon (TOC)	≤ 30 ppb
Particles (size > 0.22μm)	No particles with size > 0.22 μm if 0.22μm filter used
Bacteria	≤ 10 CFU/L (with Millipak® filter or Biopak® polisher when installed and used in a laminar flow hood)
Pyrogens (endotoxins)	< 0.001 EU/mL (with Biopak® polisher when installed and used in a laminar flow hood)
RNases	< 1 pg/mL (with Biopak® polisher)
DNases	< 5 pg/mL (with Biopak® polisher)
Proteases	< 0.15 μg/mL (with Biopak® polisher)
Production flow rate	3 L/h for IX 7003 5 L/h for IX 7005 10 L/h for IX 7010 15 L/h for IX 7015

These values are typical and may vary depending on the nature and concentration of contaminants in the feed water.

System specifications

Electrical

The power supply converts mains voltage to 28 V. The power supply is compatible worldwide.

Catalog	Frequency	Max power	Voltage
ZIX7003T0C	50-60 Hz \pm 10%	300 VA	100 – 240 V \pm 10%
ZIX7005T0C	50-60 Hz \pm 10%	300 VA	100 – 240 V \pm 10%
ZIX7010T0C	50-60 Hz \pm 10%	300 VA	100 – 240 V \pm 10%
ZIX7015T0C	50-60 Hz \pm 10%	300 VA	100 – 240 V \pm 10%

Environmental

Specific environmental conditions have to be respected to ensure normal operation of the Milli-Q system.

Location	indoor use only
Ambient operating temperature	room temperature ranges from 4°C to 40°C
Relative humidity	room relative humidity conditions of 80% for a temperature up to 31°C, decreasing linearly to a relative humidity of 50% at 40°C
Altitude	up to 3000m above sea level
Installation category	bench / underbench or wall mounted
Pollution degree	2
Noise level	< 50 dB at 1m

Communication

Each E-POD® unit has a large HD capacitive 5" touch screen (Resolution: 800*480) that allows control and monitoring of the system.

USB

The E-POD® unit has a built-in USB port that offers the possibility to export the system data and/or history. The Host interface is compliant with the USB 2.0 High-speed standard.

USB keys only work when formatted FAT32. NTFS format is not compatible.

Ethernet

When connected through an Ethernet protocol, the display interface can be accessed remotely using internet web browsers.

For best browsing performance, the recommended browser is Chrome®.

RFID (case with embedded radio feature)

Use only the built-in antenna supplied. Unauthorized modification of the antenna or use of unauthorized accessories might damage the system and render it non-compliant with the EU RED directive and/or FCC regulations.
Standard

EU

We certify that these Lab Water Systems are designed and manufactured in application of the following European Council directives:

DIRECTIVE 2014/53/EU OF THE EUROPEAN PARLIAMENT AND OF THE COUNCIL of 16 April 2014 on the harmonisation of the laws of the Member States relating to the making available on the market of radio equipment and repealing Directive 1999/5/EC.

Standards to which conformity is declared as applicable are the following.

Electromagnetic compatibility and Radio spectrum Matters(ERM) tests according to standards: ETSI EN 300 330.

FCC

FCC part 15: 2014 Code of federal regulations.

Title 47 – Telecommunication chapter 1- Federal Communication Commission.

Part 15- Radio frequency devices Sub-part C- Intentional Radiators Limits and Methods of measurement of radio disturbance.

System software

System software included in this product contains copyrighted software that is licensed under the GNU GPL.

The legal notices are available in the E-POD® unit display: Information menu > *System* app > Legal Notices.

Power and water consumption

Power consumption

The actual power consumption in each mode is described below:

Catalog	Standby (W)	Recirculation (W)	Distribution (W)	Production (W)	Production + distribution (W)
ZIX7003T0C	30	48	55	60	87
ZIX7005T0C	30	48	55	65	89
ZIX7010T0C	30	48	55	78	95
ZIX7015T0C	30	48	55	90	100

The following data have been collected according the experimental method described below:

- Production time of 5 hours or 20 hours per day.
- One manual recirculation before each dispense (30s).
- One recirculation after each dispense (30s).
- Each hour, 3 minutes of automatic recirculation.
- 50 Weeks ON and 2 weeks OFF.
- The produced water is dispensed on the E-POD® unit.

If the water system is in tank filling 5 hours a day

Catalog	Daily water produced (L)	Daily amounts of dispenses	Yearly energy consumption (kWh)
ZIX7003T0C	15	10	309
ZIX7005T0C	25	15	316
ZIX7010T0C	50	20	333
ZIX7015T0C	75	30	351

If the water system is in tank filling 20 hours a day

Catalog	Daily water produced (L)	Daily amounts of dispenses	Yearly energy consumption (kWh)
ZIX7003T0C	60	10	413
ZIX7005T0C	100	30	434
ZIX7010T0C	200	40	478
ZIX7015T0C	300	60	518

Water consumption

Depending upon the water system type and feed water quality, an average of 5.5 L of feed water is needed to produce 1 L of type 2 purified water.

Dimensions and weights

Water purification system (7003/7005): dimensions in mm.

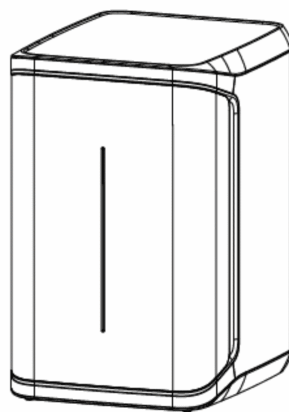
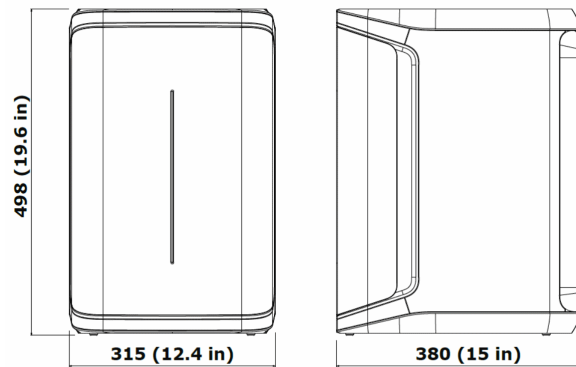

Water purification system (7010/7015): dimensions in mm.

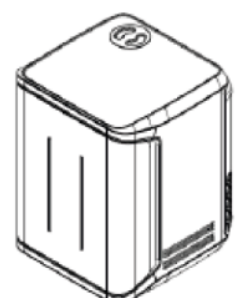
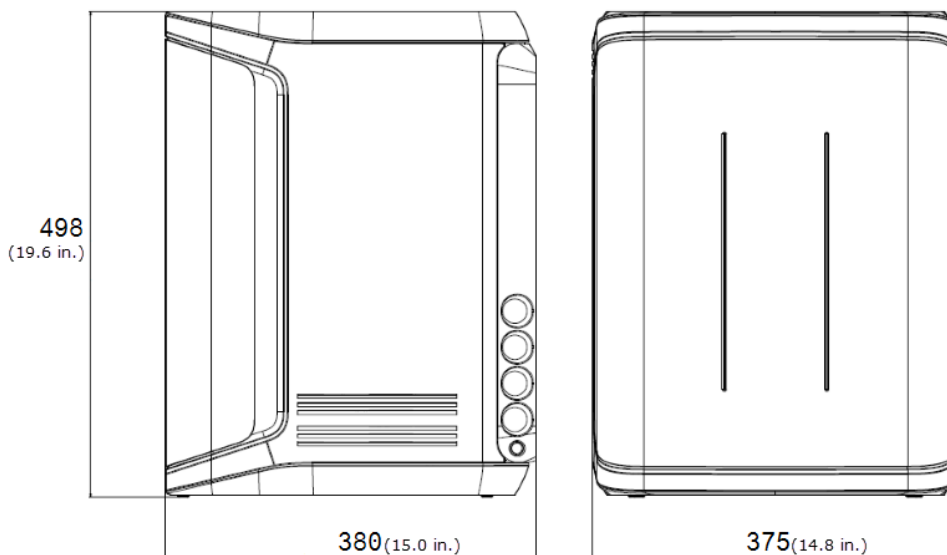

E-POD® unit: dimensions in mm.

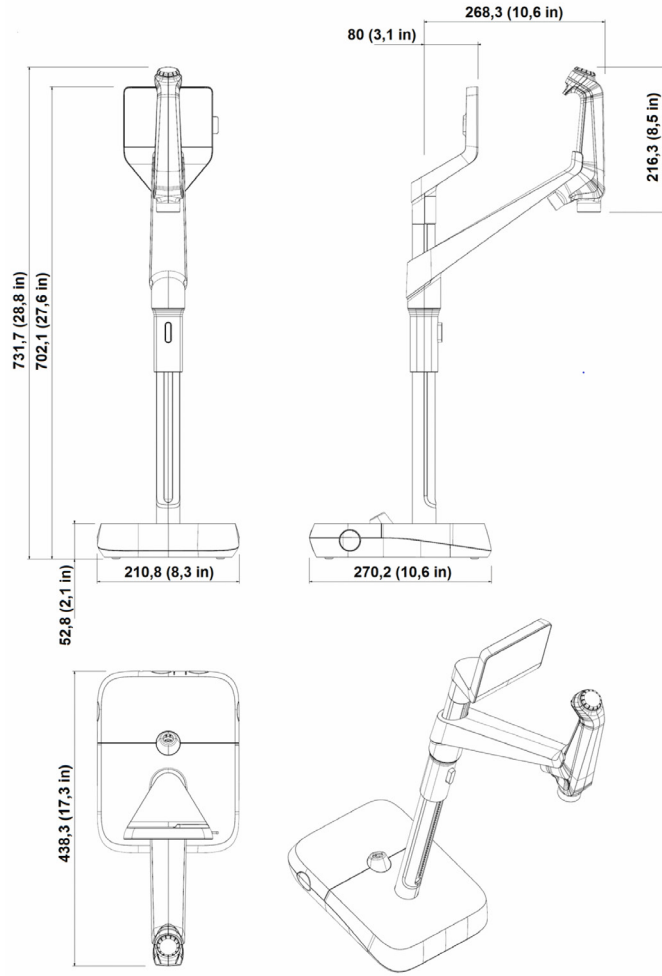

Storage tank 25L - 50 L - 100 L: dimensions in mm.

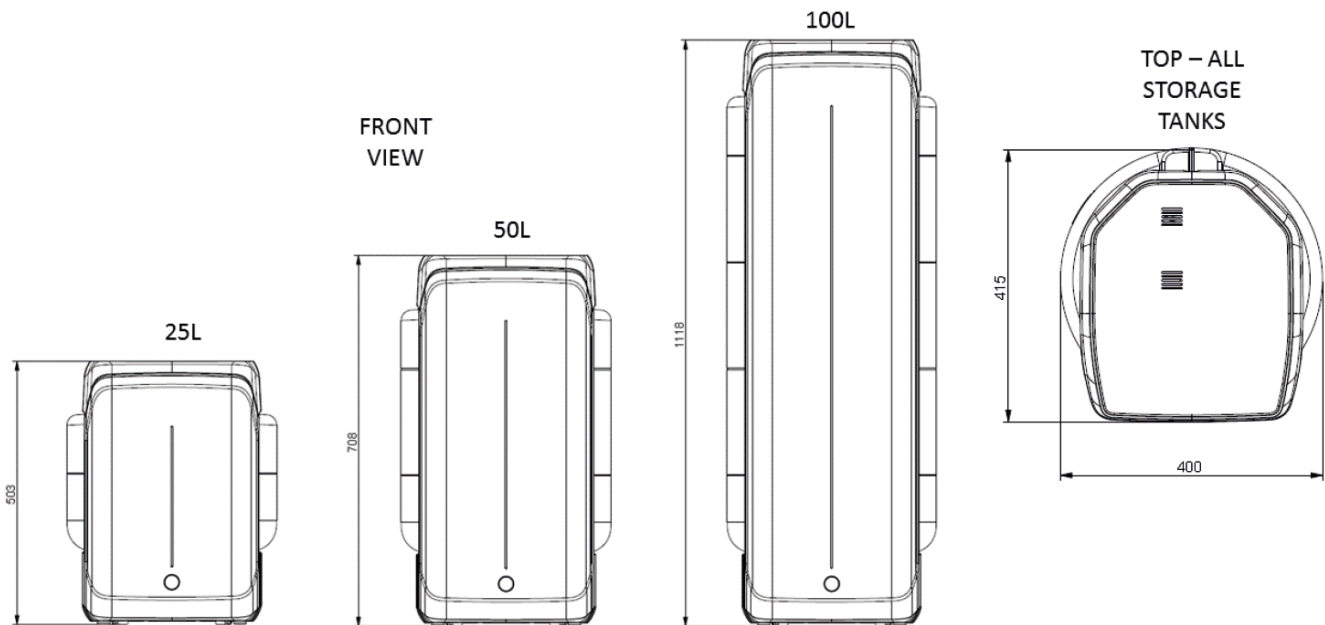

System Type	Dry weight	Shipping weight	Operating weight
Milli-Q® IX 7003/7005 system	19.5 kg (43.1 lb)	22.5 kg (49.7 lb)	23.4 kg (51.6 lb)
Milli-Q® IX 7010 system	22.2 kg (49.0 lb)	25.4 kg (56.1 lb)	27.1 kg (59.8 lb)
Milli-Q® IX 7015 system	22.5 kg (49.7 lb)	25.7 kg (56.7 lb)	27.4 kg (60.5 lb)
E-POD® unit	4.7 kg (10.4 lb)	7.2 kg (15.9 lb)	5.5 kg (12.1 lb)
Water storage 25 L	6.7 kg (14.8 lb)	8.5 kg (18.7 lb)	31.7 kg (69.9 lb)
Water storage 50 L	7.6 kg (16.8 lb)	10.6 kg (23.4 lb)	57.6 kg (127 lb)
Water storage 100L	10.9 kg (24.0 lb)	12.8 kg (28.2 lb)	110.9 kg (244.5 lb)

Dry Weight is defined as a system without its shipping container. Consumables and accessories are not included.

Shipping Weight is defined as a dry system in its shipping container. Consumables and accessories are not included.

Operating weight is defined as a wetted system with all its consumables, but not any accessories.



Recycling

Directive 2012/19/UE:

For European users only

The symbol “crossed bin” on a product or its packaging indicates that the product should not be treated like household waste when discarded. Instead the product should be disposed of at a location that handles discarded electric or electronic equipment.

Proper disposal of equipment containing electric or electronic components will help to reduce pollution effects to the environment or to human health. Proper recycling of these products helps in environmental preservation and helps to protect natural resources. For more information about recycling of products containing electric or electronic components, please contact your local recycling representative or organization.

Ordering information

System components

Name	Catalog Number
E-POD® Remote Dispenser (E-POD® unit)	ZIQEP0D00
Storage tank frame 25 L	TANKA025
Storage tank frame 50 L	TANKA050
Storage tank frame 100 L	TANKA100
Storage tank top assembly	TANKT0PA1
Connector 2m System-POD	ZFC0NN2SQ
Connector 5m System-POD	ZFC0NN5SQ
Connector 2m POD-POD	ZFC0NN2QQ
Connector 5m POD-POD	ZFC0NN5QQ
Connector 2m System-Tank	ZFC0NN2ST
Connector 5m System-Tank	ZFC0NN5ST

Accessories

Name	Catalog Number
Water sensor	ZWATSENA1
Foot pedal	ZMQSFTSA1
Alarm relay cable	ZMQ0ALCA1
Washer Distribution kit 230V Left	ZWDK5L100
Washer Distribution kit 230V Right	ZWDK5R100
Washer Distribution kit 115V Left	ZWDK6L100
Washer Distribution kit 115V Right	ZWDK6R100
Washer Distribution kit Adaptor	ZWDKADPA1
Washer dist kit wall mounting bracket	WMBWASHA1
System Wall Mounting Bracket	SYSTFIXA1
Wall mounting bracket for storage tank	TANKFIXA1
Sanitary valve kit	ZIQ7ESP01
External solenoid valve	EXTSV00A1
Multi system installation kit	ZIQ7MSKT1
Tank level adapter	ZSTWIN0A1

Description	Catalog Number
MILLI-Q® IX 7003-5 PURIFICATION KIT	IX700XPKT1
Milli-Q® IX 7010-15 PURIFICATION KIT	IX70XXPKT1
MILLI-Q® IX 7003-15 ECH ₂ O® LAMP KIT	IX7XUVKT1
Millipak® 0.22µm filter	MPGP002A1
Millipak® Gold 0.22µm sterile filter	MPGPG02A1
Biopak® polisher (filter)	CDUFBI0A1
ROCare A	ZWACID012
ROCare B	ZWBASE012
ROProtect C	ZWCL01F50
EfferSan Effervescent Tablets (US)	5874316024
IPAK Gard® 3-5 pretreatment pack	IPAKGARA1
IPAK Gard® 10-15 pretreatment pack	IPAKGARA2
Ech ₂ o® ASM Lamp	ASMUVLPA1
Ech ₂ o® Bactericidal Lamp	ZIXUVLPA1
Vent filter HF (for high flow applications)	TANKVH1A1
Vent filter	TANKV01A1
Prepak filter pretreatment pack	PRPK000A1

Note:

- MILLI-Q® IX 7003-5 PURIFICATION KIT is composed of 1 IPAK Gard® 3-5 pretreatment pack and 1 tank vent filter.
- Milli-Q® IX 7010-15 PURIFICATION KIT is composed of 1 IPAK Gard® 10-15 pretreatment pack and 1 tank vent filter.
- MILLI-Q® IX 7003-15 ECH₂O® LAMP KIT is composed of 1 Ech₂o® ASM Lamp and 1 Ech₂o® Bactericidal Lamp.
- IPAK Gard® 10-15 pretreatment pack includes both IPAK Gard® cartridges needed for a Milli-Q® IX 7010/7015 system.

LEGAL INFORMATION & WARRANTY

It has always been Millipore SAS policy to continuously improve its products.

The information in this document is subject to change without notice and should not be construed as a commitment by Millipore SAS. Millipore SAS assumes no responsibility for any errors that might appear in this document. This user manual is believed to be complete and accurate at the time of publication. In no event shall Millipore SAS be liable for incidental or consequential damages in connection with or arising from the use of this user manual.

Product warranty and limitation of liability

The applicable warranty and limitation of liability for the products listed in this publication may be found at www.sigmaaldrich.com within the "Conditions of Sale" applicable to your purchase transaction.

Copyright

© Millipore SAS 2020.

All rights reserved. This document or parts thereof may not be reproduced in any form without the written permission of Millipore SAS.

The photographs illustrating the products are non-contractual.

Trademarks

New trademark names

The initial M, Millipore, Milli-Q, E-POD, ech₂o, IPAK Gard, Millipak and Biopak are trademarks of Merck KGaA, Darmstadt, Germany.

Millipore SAS is an affiliate of Merck KGaA, Darmstadt, Germany.

QR Code is a registered trademark of DENSO WAVE INCORPORATED in Japan and other countries.

All other trademarks are trademarks of their respective manufacturers.

The Life Science Business of Merck KGaA, Darmstadt, Germany operates as MilliporeSigma in the US and Canada.

Safety information

Your Milli-Q® system should be operated according to the instructions in this user manual. In particular, the hydraulic and electrical specifications should be followed and met. It is important to use this equipment as specified in this manual; using this equipment in a different manner may impair the safety precautions of the Milli-Q® system.

Never open the system, even when the power switch has been switched off. Hazardous voltage is present. It is not sufficient to stop all power to system, the plug must be physically removed from its power source. Installation and maintenance should only be done by a qualified person. Appropriate personal protective equipment (PPE) must be worn and safe work practices must be followed.





Document Reference: UM_MILLI-Q_IX_7003_7005_7010_7015_User_Manual_EN

Revision: V4.0

Safety information

Never open the system, even when the power switch has been switched off.

100-240 V ELECTRICITY AND UV LIGHT INSIDE!

Symbol	What it means
	This UV RADIATION sticker is used to refer to a position on the Water System Cabinet or inside of it where exposure to UV light is possible
	This DANGER sticker is used to refer to a position on the Water System Cabinet or inside of it that could be hazardous.
	This ELECTRICAL GROUND sticker is used to refer to a position on the Water System Cabinet or inside where an electrical ground connection is made.
 Hazard	The Milli-Q® system must be connected to a source of electrical power that is earth grounded.
 Attention	Before the system is serviced, unplug the electrical power cord. The Milli-Q® system must be powered OFF before plugging in or removing any components on the electronic board(s).

The Milli-Q® IX 7003/7005/7010/7015 has been tested by an independent and accredited company for compliance with EU directives related to safety and electromagnetic compatibility. The declaration of conformity is available upon request. The system has been manufactured using components and practices recommended by UL and has been cULus marked. The registration and CB certificates can be verified at www.members.IECEE.org.

In case of wall mounted installation:

For the system Milli-Q® IX 7003/7005/7010/7015 : Use a wall capable of supporting a minimum load of 120 kg. Use 6mm diameter stud and fasteners capable to support a minimum load of 60 kg each.

For the 25L tank: Use a wall capable of supporting a minimum load of 130 kg. Use 6mm diameter stud and fasteners capable to support a minimum load of 45 kg each.

For the 50L tank: Use a wall capable of supporting a minimum load of 240 kg. Use 6mm diameter stud and fasteners capable to support a minimum load of 80 kg each.

For the 100L tank: Use a wall capable of supporting a minimum load of 500 kg. Use 6mm diameter stud and fasteners capable to support a minimum load of 180 kg each.