



Simplicity® system
Simplicity UV system
User manual



Notice

The information in this document is subject to change without notice and should not be construed as a commitment by Millipore SAS. Millipore SAS assumes no responsibility for any errors that might appear in this document. This manual is believed to be complete and accurate at the time of publication. In no event shall Millipore SAS be liable for incidental or consequential damages in connection with or arising from the use of this manual.

We manufacture and sell water purification systems designed to produce pure or ultrapure water with specific characteristics ($\mu\text{S}/\text{cm}$, T, TOC, CFU/ml, Eu/ml) when it leaves the water purification system provided that the Systems are fed with water quality within specifications, and properly maintained as required by the supplier.

We do not warrant these systems for any specific applications. It is up to the end user to determine if the quality of the water produced by our systems matches his expectations, fits with norms/legal requirements and to bear responsibility resulting from the usage of the water.

Copyright

© 2012 MILLIPORE SAS. PRINTED IN FRANCE. ALL RIGHTS RESERVED. THIS BOOK OR PARTS THEREOF MAY NOT BE REPRODUCED IN ANY FORM WITHOUT THE WRITTEN PERMISSION OF THE PUBLISHERS.

THE PHOTOS ARE NON-CONTRACTUAL.

FTPF09582

V3.0 – 05/2012

Trademarks

Millipore, Simplicity, SimpliPak, Elix, BioPak and Millex are registered trademarks of Merck KGaA.

SimFilter, EDS-Pak and VOC-Pak are trademarks of Merck KGaA.

The "M" Mark is a trademark of Merck KGaA.

All other trademarks are trademarks of their respective manufacturers.

Product warranty and limitation of liability

The applicable warranty and limitation of liability for the products listed in this publication may be found at <http://www.millipore.com/ec/cp3/terms> within the "Terms and Conditions of Sale" applicable to your purchase transaction.



Directive 2002/96 EC: For European users only

The symbol "crossed bin" on a product or its packaging indicates that the product should not be treated like household waste when discarded. Instead the product should be disposed of at a location that handles discarded electric or electronic equipment.

Proper disposal of equipment containing electric or electronic components will help to reduce pollution effects to the environment or to human health. Proper recycling of these products helps in environmental preservation and helps to protect natural resources. For more information about recycling of products containing electric or electronic components, please contact your local recycling representative or organisation.

Table of Contents

Introduction	1
Using this Manual	1
Safety Information	1
Contacting Millipore® SAS.....	2
Product Information.....	3
Simplicity System Overview.....	3
Simplicity System Product Water Specifications.....	3
Schematic of Main Components.....	4
Operating principle	4
Technical Specifications	5
Pre Installation	7
Installation Requirements.....	7
Optional Equipment You May Need	7
Unpacking the Simplicity System– What’s Inside?	7
Installation	9
Preparation of the System	9
Filling the Internal Tank.....	9
Installation of the Tank Vent Filter.....	10
Connection of the Power Cord – Turning on the System Power	11
Installation of the SimpliPak cartridge.....	12
Installation of the Tygon® Tubing.....	14
Purging Air from the System.....	15
Hydrating the System.....	15
Installation and Rinsing of the Final Filter	16
How to Show Resistivity or Conductivity Units (C01).....	17
How to Set the Resistivity Setpoint (C02).....	19
Using the Simplicity System.....	21
Understanding the Display.....	21
How to Get Water from the Simplicity System.....	21
Operating Modes	22
How to view the Product Resistivity and Temperature in Pre Operate mode	23
How to recirculate water manually before dispensing	23
How to Understand Simplicity system messages.....	24

Maintenance	25
Maintenance Schedule.....	25
How to Replace the SimpliPak cartridge.....	26
How to Replace the Final Filter.....	29
How to Calibrate the Tank Level (C03).....	30
How to Replace the UV Lamp (UV System only).....	32
How to View or Reset the UV Lamp Timer (C04).....	35
Troubleshooting	37
Ordering Information	39
Catalogue Numbers for Simplicity Systems	39
Catalogue Numbers for Consumables.....	39
Catalogue Numbers for Accessories.....	39

Using this Manual

This User Manual is a guide for use during the installation, normal operation and maintenance of a Simplicity or Simplicity UV Water Purification System. 'Simplicity System' is used in this manual to refer to either the Simplicity or the Simplicity UV Water Purification System unless otherwise noted. It is highly recommended to completely read this manual and to fully comprehend its contents before attempting normal operation or maintenance of the Water Purification System.

Safety Information

Your Simplicity System should be operated according to the instructions in this manual. In particular, the hydraulic and electrical specifications should be followed and met. It is important to use this equipment as specified in this manual; using this equipment in a different manner may impair the safety precautions of the Simplicity System.

Symbol

What it means



This HAZARD symbol is used to refer to instructions in this manual that need to be done safely and carefully.



This ATTENTION symbol is used to refer to instructions in this manual that need to be done carefully.



this UV RADIATION sticker is used to refer to a position on the system cabinet or inside of it where exposure to UV light is possible.



This DANGER sticker is used to refer to a position on the system cabinet or inside of it that could be hazardous.



this ELECTRICAL GROUND sticker is used to refer to a position on the system cabinet or inside where an electrical ground connection is made.



this ELECTRICAL DANGER sticker is used to refer to a position on the system cabinet or inside where an electrical danger could exist.

Introduction

Contacting Millipore® SAS

Internet

The Millipore SAS Internet Site can be used to find addresses, telephone/fax numbers and other information.

Internet Site Address: www.millipore.com
www.millipore.com/techservice
www.millipore.com/lab_water

Manufacturing Site

Millipore SAS
67120 Molsheim
FRANCE

Simplicity System Overview

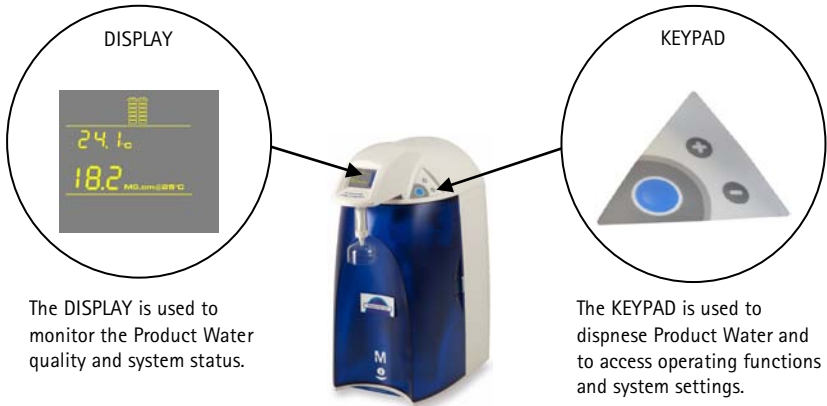

Simplicity System Product Water Specifications

Water Flowrate Specifications

Up to 0.5 LPM (with Final Filter)

Product Water Quality

Resistivity	18.2 MΩ.cm @ 25 °C
Total Organic Carbon (TOC)*	< 5 µg/L (ppb) (with UV) < 15 µg/L (ppb) (without UV)
Micro-Organisms	< 0.1 CFU/ml (with Final Filter)

***Test Conditions:** The system was equipped with a SimpliPak® 1 cartridge. The feedwater for the reservoir came from an Elix® system. The TOC in the feedwater was < 50 ppb. The quality of the Product Water can vary as a function of the quality of the feedwater.

Product Information

Schematic of Main Components

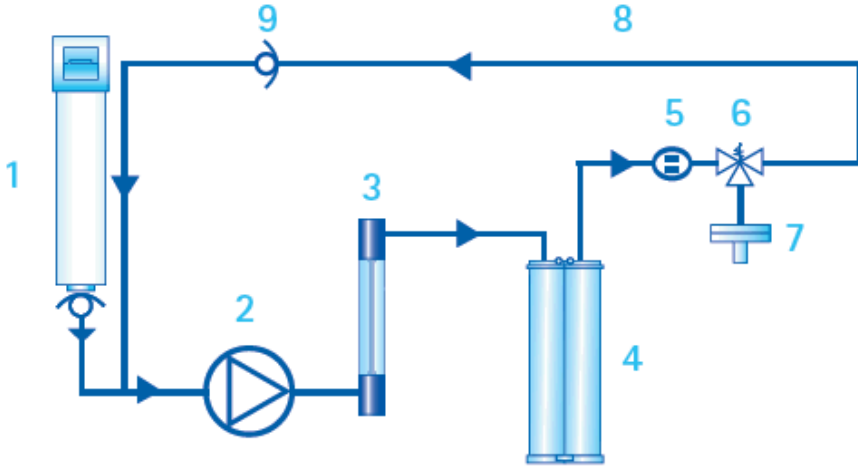

- 1 2 Litre Tank
- 2 Distribution Pump
- 3 UV Lamp 185 nm (UV System)
- 4 SimpliPak 1, 2 or 3 Cartridge

- 5 Product Resistivity Cell & Thermistor
- 6 Point-of-Use (POU) Solenoid Valve
- 7 Final Filter
- 8 Recirculation Loop

Operating principle

The Simplicity Water Purification System is fed with pretreated water (Elix system, RO, distilled or DI water) through an internal tank.

When Product Water is being dispensed, the Distribution Pump turns on. The feedwater (pretreated) water is then pumped into the UV Lamp (UV System only). The UV Lamp emits light at 185 nm and 254 nm. It is used to reduce levels of organic molecules in the water. The UV Lamp is a consumable device that needs to be periodically replaced during the maintenance of the system. The water is then sent to the SimpliPak cartridge to deionize the water. There are three types of SimpliPak cartridges. The SimpliPak 1 cartridge is used for Elix system, RO or distilled feedwater. The SimpliPak 2 cartridge is used for pretreated water from clean DI (particulate-free). The SimpliPak 3 cartridge is used for pretreated water from dirty DI (non particulate-free). The SimpliPak cartridge is a consumable device that needs to be periodically replaced during the maintenance of the system.

The Final Filter is a membrane based filter that removes all particles and bacteria with a size greater than the filter pore size. The Final Filter is a consumable device.

Technical Specifications

Dimensions

System Height, Width and Depth

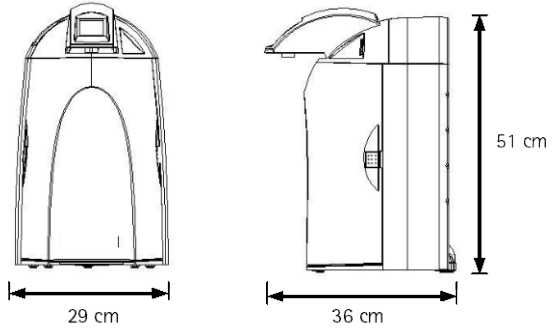

Shipping Box

- Height: 56 cm
- Width: 42 cm
- Depth: 64 cm

Weight

	Simplicity system	Simplicity UV system
Operating Weight	8.4 kg	9.0 kg
Dry Weight	4.9 kg	5.4 kg
Shipping Weight	10.2 kg	10.7 kg

Noise Level

A Simplicity System has a maximum noise level of 50 dB at a distance of 1 metre away.

Electrical

- 100 VAC \pm 10%, 50/60 Hz. 0.56 amp source, 2 amp T (Time Lag) fuse, Power = 80 VA
- 120 VAC \pm 10%, 50/60 Hz. 0.56 amp source, 2 amp T fuse, Power = 80 VA
- 230 VAC \pm 10%, 50/60 Hz. 0.31 amp source, 2 amp T fuse, Power = 80 VA



The source of electrical power should be within 2.5 metres of the system. The source of electrical power must be earth grounded.

Installation Requirements

Pretreated water Requirements

Type of pretreated water	Elix system, RO, distilled or DI water
Temperature	5 to 35 °C

Environmental Requirements

Indoor Use Only	
Ambient Storage Temperature	5 °C < T < 40 °C
Ambient Operating Temperature	5 °C < T < 40 °C
Relative Humidity	Should not exceed 80% for temperatures below 31 °C Should stay within 50% to 80% between 31 °C and 40 °C.
Altitude	< 3000 metres
Installation Category	II
Pollution Degree	2

Optional Equipment You May Need

Wall Mounting Bracket

The Catalogue Number for the Wall Mounting Bracket is WMBSMT002. The mounting hardware for attaching the bracket to a wall is not included and must be supplied.

Unpacking the Simplicity System– What's Inside?

Open the Simplicity System Shipping Box. Use the checklist included in the Accessories Bag to make sure all items were shipped and are accounted for. It is highly suggested to become familiar with the items that are shipped since these will be used in the Installation section of this manual.

Contact Millipore SAS if an item is missing.

Preparation of the System

A



- Locate the protective foam found at the UV lamp cable. Remove it (see photo A).
-

Filling the Internal Tank

B



- Place your hand under the tank handle (B).
-

C



- Raise and pull out the tank using the tank handle (C).
-

D



- Remove the tank lid (D).
 - Fill the tank with pretreated water.
 - Re-install the tank inside the system.
 - Push in on the tank lid to fit the tank in place. This will allow the water level in the tank to be detected and properly displayed on the Display screen.
-

Installation

Installation of the Tank Vent Filter

A



- Insert the Vent Filter into the tank lid (A). Press firmly on the filter to secure the Luer connection.
-

B



- Re-install the tank lid (B).
-

Connection of the Power Cord – Turning on the System Power



- Open the front cover of the system (A). This will allow the system to go into STANDBY mode once the system is powered.
-



- Plug the Power Cord into the system (B).
 - Plug the other end of the Power Cord into an appropriate source of electrical power (i.e. wall outlet). The system is immediately powered.
-

Start-up Displays

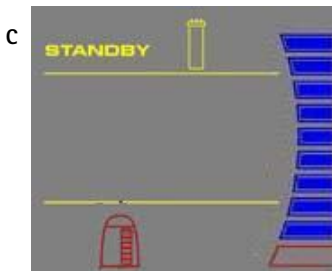

- Once the system is powered, the system will start to display information about the software before going into STANDBY mode (C).
-

Installation

Installation of the SimpliPak cartridge



Do not touch the UV Lamp when replacing the SimpliPak cartridge.

Installation

A

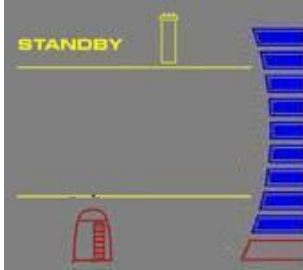

-
- Make sure the front cover is opened. STANDBY should be viewed on the Display (A).
 - Remove the SimpliPak from its shipping box.
 - Remove the protective caps on the ports of the SimpliPak cartridge and from the system.
 - Locate the O-rings on the ports. Wet them with water. It is preferable to wet them with ultrapure water.
-



- Install the SimpliPak until it is fully seated into the system ports as shown (B, C and D).
-

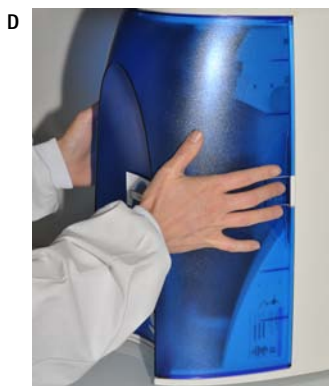

- **CLOSE THE FRONT COVER.**
-

Installation

Installation of the Tygon® Tubing



Do not use any white tape on the threads of the Barbed Fitting. An O-ring is located inside the POU Dispenser to ensure water tightness between the threads of the POU Dispenser and the Barbed Fitting.



- Locate the clear Tygon Tubing and the Barbed Fitting from the Accessories Bag.
 - Screw the Barbed Fitting onto the bottom end of the POU Dispenser (A).
-

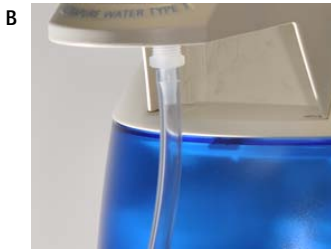

- Push one end of the Tygon Tubing onto the end of the Barbed Fitting (B). Place the other end of the Tygon Tubing in a sink.
-

Purging Air from the System

A



- At this time you should have installed the SimpliPak cartridge, Barbed Fitting and the Tygon Tubing. Air trapped in the SimpliPak cartridge should now be purged from the system.
- Press the Main Button to put the system into DISPENSING mode (A).
- Dispense 2 Litres of water from the system.
- Stop dispensing by pressing on the Main Button.

Hydrating the System

- At this time, the Final Filter is not installed. Leave the system overnight or for several hours in PRE OPERATE mode (*see Section Operating Modes*). The system will regularly recirculate water and rinse off purification media inside the SimpliPak cartridge. Do not leave the system in STANDBY mode.
- (The next morning) Press the Main Button to put the system into DISPENSING mode.
- Allow about 0.5 Litre of water to be dispensed from the system.
- Press the Main Button. The system will finish dispensing water.
- Remove the Tygon Tubing and the Barbed Fitting from the POU Dispenser.
- The Final Filter needs to be installed.
(*See Section Installation and Rinsing of the Final Filter*).

Installation

Installation and Rinsing of the Final Filter

A

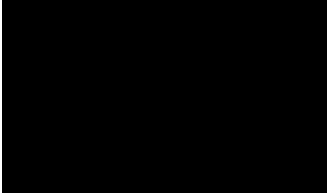

- Obtain a Final Filter. It can be the SimFilter™ Final Filter or the BioPak® Ultrafiltration Cartridge.
- Remove the Tygon Tubing and the Barbed Fitting from the POU Dispenser.
- Screw the Final Filter onto the end of the POU Dispenser. The Final Filter should be turned until it is hand tight (A). Do not over tighten the Final Filter.



ATTENTION

Do not use white tape on the threads of the Final Filter. The POU Dispenser has an O-ring inside which provides a watertight seal.

B



- Press the Main Button to put the system into DISPENSING mode (B).
- For the SimFilter Final Filter, dispense about 0.5 Litre of water. For the BioPak Cartridge, refer to the instructions shipped with the filter.
- Press the Main Button. The system will finish dispensing water.
- Leave the system in PRE OPERATE mode.



ATTENTION

It is highly recommended not to put Tygon Tubing or any other type of tubing on the end of the Final Filter. This can compromise the Product Water quality (bacteria can grow in the Tygon Tubing).

- The Water System is now ready for use.

How to Show Resistivity or Conductivity Units (C01)

With Temperature Compensated or non Temperature Compensated values

Temperature compensation is a way of 'standardizing' Resistivity or Conductivity to measurements that would be seen if the water temperature was 25 °C.

1



Press the Main and "+" Buttons together to enter the menu. The Display will show C01 and the units chosen. The following Display shows Temperature Compensated Resistivity Units: $M\Omega.cm @25\ ^\circ C$.



2



Press the "+" or "-" Button to select Non Temperature Compensated Resistivity Units: $M\Omega.cm$.

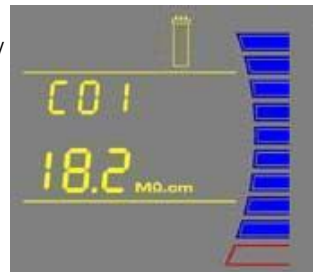

3



Press the "+" or "-" Button to select Temperature Compensated Conductivity Units: $\mu S/cm @25\ ^\circ C$.



Installation

4



Press the "+" or "-" Button to select Non Temperature Compensated Conductivity Units: $\mu\text{S}/\text{cm}$.

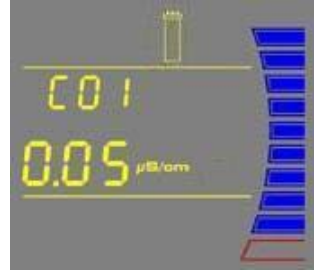

5



To exit the menu, press and hold the Main Button for 2 seconds.

To display the next menu option, press the Main Button once.

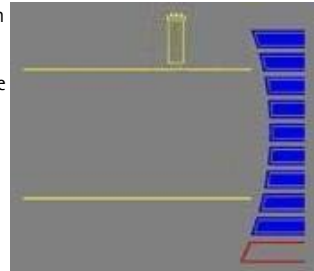

How to Set the Resistivity Setpoint (C02)

The Resistivity Setpoint is used to inform you when the Product resistivity is low. When the resistivity is below the setpoint, the Resistivity display will flash and the red Pack Alarm will be blinking (see *Section How to Understand Simplicity system messages*). The factory default resistivity value is set to 15 M Ω .cm @25 °C.

1



Press the Main and "+" Buttons together to enter the menu. The Display will show C01.

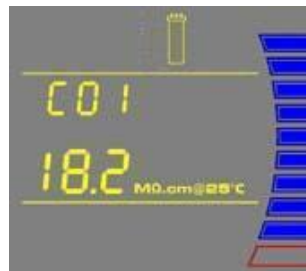

2



Press the Main Button once. The Display will show C02 and the Resistivity Setpoint value.

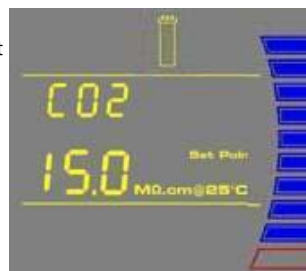

3



Press the "+" or "-" Button to adjust the Resistivity Setpoint from 1.0 M Ω .cm @25 °C to 18.0 M Ω .cm @25 °C.

If Conductivity Units are chosen in C01, then the Setpoint can be adjusted from 0.999 μ S/cm @25 °C to 0.055 μ S/cm @25 °C.

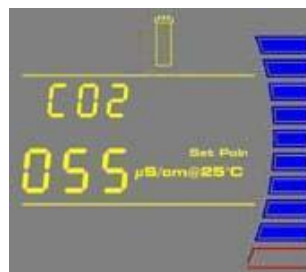

NOTE:

The Conductivity Setpoint display needs to be multiplied by 0.001 to get the real value. For example, if the Display reads "055" μ S/cm @25 °C, then you would multiply 055 x 0.001 = 0.055. Thus, the real Conductivity Setpoint reading is 0.055 μ S/cm @25 °C.

Installation

4



To exit the menu, press and hold the Main Button for 2 seconds.

To display the next menu option, press the Main Button once.

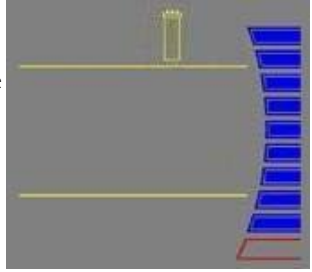

Understanding the Display

The Display is used to view information about the Operating Modes, the Operating Parameters and Maintenance or Alarm messages.

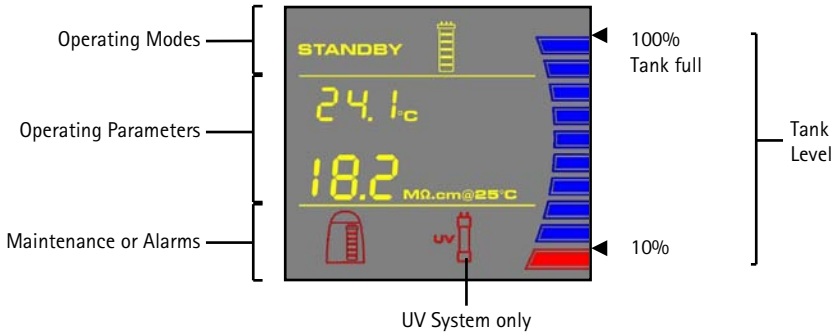

How to Get Water from the Simplicity System

Using the Keypad



- To DISPENSE water, press the Main Button.

NOTE:

To stop dispensing water, press the Main Button again. Water can be dispensed only if the water level is above 10%. The system will automatically stop dispensing water after 10 minutes.

Maintaining a minimum level of water in the tank

- The Simplicity System is fed by the internal tank in the system. The actual water level in the tank can be viewed in PRE OPERATE mode. Whenever the tank level is close to 10%, the tank should be refilled.
- If the 10% level is blinking on the Tank Level display (red level), then the tank is empty. No water can be dispensed from the system. The tank needs to be refilled.

NOTE:

The tank lid may need to be pushed in to fit the tank in place. This will allow the water level in the tank to be detected and properly displayed on the Display screen.

Operating Modes

Standby

STANDBY mode is displayed when the front cover is removed. To depressurize the system, the Main Button has to be pressed down when STANDBY is blinking on the Display for 10 seconds. All system operations are disabled. STANDBY mode is selected before attempting maintenance on the system.

The word "STANDBY" is displayed in large, bold, yellow capital letters on a dark grey rectangular background.

Pre Operate

PRE OPERATE Mode is displayed when the system is not dispensing water and the front cover is installed.

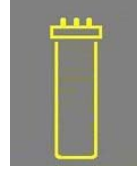

The system will have a 3-minute auto-recirculation every 2 hours in PRE OPERATE mode. The Distribution Pump turns on. This will enhance the quality of the Product Water delivered from the system. Recirculation can also be activated manually for up to 3 minutes.



Recirculation during PRE OPERATE mode

The resistivity and temperature of the Product Water are displayed during recirculation. The resistivity and temperature remain displayed for up to 10 seconds after recirculation is finished.

Dispensing

DISPENSING mode is displayed when Product Water is being dispensed. DISPENSING mode occurs because the Main Button was pressed. The Distribution Pump turns on.

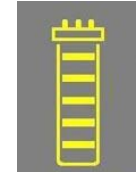

The resistivity and temperature of the Product Water are displayed during dispensing. The resistivity and temperature remain displayed for up to 10 seconds after dispensing is stopped.

The display shows two lines of yellow text on a dark grey background. The top line shows "24.1" followed by a small "c" symbol. The bottom line shows "18.2" followed by "MΩ.cm@25°C".

How to view the Product Resistivity and Temperature in Pre Operate mode

Press:



The Display will show the last Product resistivity and temperature values measured during DISPENSING mode or during RECIRCULATION. The values are displayed for 5 seconds.



NOTE:

The Product resistivity and temperature are displayed automatically during DISPENSING mode or during RECIRCULATION.

How to recirculate water manually before dispensing

This option is used to enhance the quality of the Product Water before dispensing water. The Distribution Pump will turn on and water will recirculate for up to 3 minutes. An auto-recirculation occurs for 3 minutes every 2 hours.

Press:



The Display will show the Product resistivity and temperature.



NOTE:

To dispense water, press the Main Button during recirculation. Recirculation will stop and water will be dispensed.

How to Understand Simplicity system messages

Pack Alarm



- The system will prompt you to change the SimpliPak cartridge using a red Pack Alarm icon. The Display will show the red Pack Alarm blinking. The SimpliPak cartridge is changed due to either the amount of time it has been used or from the amount of water that has passed through it.



- When the Resistivity display is blinking, the red Pack Alarm will also be blinking. This indicates that the SimpliPak cartridge should be replaced. This message is shown when the Product resistivity is less than the Resistivity Setpoint. The Resistivity Setpoint can be seen in menu option C02



- When the red Pack Alarm is displayed as a steady icon, the SimpliPak cartridge is not installed correctly or not installed at all. If the SimpliPak cartridge has been reinstalled and the Alarm is still displayed, then contact your technical support.

UV Lamp Alarm

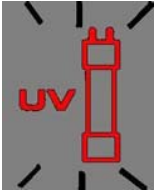



- The system will prompt you to change the UV Lamp using a red UV Lamp Alarm icon. The Display will show the red UV Lamp Alarm blinking. The message is shown when the UV Timer displays 0 days. The UV Timer can be viewed in menu option C04. The replacement of the UV Lamp involves the installation of a new UV Lamp and a manual reset of the UV Timer.



- When the red UV Lamp Alarm is displayed as a steady icon, the UV Lamp is not installed correctly or not installed at all. If the UV Lamp has been reinstalled and the Alarm is still displayed, then contact your technical support.

Maintenance Schedule

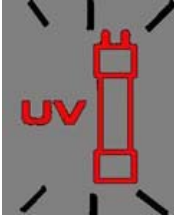
What to do	When?	How to?
SimpliPak Cartridge Replacement	<p>When the Pack Alarm display is blinking.</p>  <p>When the system resistivity display is blinking.</p> 	See Section How to Replace the SimpliPak cartridge
Final Filter Replacement	The SimFilter Final Filter is replaced when the SimpliPak cartridge is replaced or when the Product Water flowrate drops. The BioPak cartridge should be replaced every 90 days.	See Section How to Replace the Final Filter
Tank Level Calibration	Periodically.	See Section How to Calibrate the Tank Level (C03)
UV Lamp Replacement and UV Timer Reset	<p>When the UV Lamp Alarm display is blinking.</p> 	See Section How to Replace the UV Lamp (UV System only) and How to View or Reset the UV Lamp Timer (C04)

Maintenance

How to Replace the SimpliPak cartridge



Do not touch the UV Lamp when replacing the SimpliPak cartridge.

Removing the SimpliPak cartridge

A



- Remove the Final Filter.
- Open the front cover to go into STANDBY mode. Press the Main Button. Wait for the system to depressurize. The Display will show STANDBY blinking for 10 seconds.
- Press your thumbs on the system (A).

B



- Swing the pack towards you and remove the pack from the system (B).
-

Installing the new SimpliPak cartridge

D



- Remove the new SimpliPak cartridge from its shipping box.
 - Remove the protective caps on the ports of the SimpliPak cartridge.
 - Locate the O-rings on the ports. Wet them with water. It is preferable to wet them with ultrapure water.
 - Install the SimpliPak cartridge until it is fully seated into the system ports as shown (D, E and F).
-

E



F



- **CLOSE THE FRONT COVER.**
-

Maintenance

G



- Install the Barbed Fitting and Tygon Tubing (G).
(See Section Installation of the Tygon® Tubing).
-

Purging Air from the System

- *(See Section Purging Air from the System).*
-

Hydrating the System

H



- Hydrate the system (H).
(See Section Hydrating the System).
-

Replacing the Final Filter

- *See Section How to Replace the Final Filter.*

The System is now ready for use.

How to Replace the Final Filter

The Final Filter is normally replaced when the SimpliPak cartridge is replaced or at an earlier time if it becomes clogged. A clogged Final Filter can reduce the Product Water flowrate.



ATTENTION

Make sure the SimpliPak cartridge has been hydrated overnight.

A

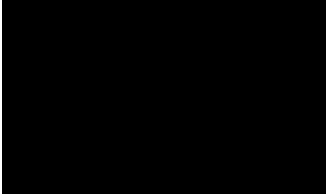

- Remove the used Final Filter.
- Screw the new Final Filter onto the end of the POU Dispenser. The Final Filter should be turned until it is hand tight (A). Do not over tighten the Final Filter.



ATTENTION

Do not use white tape on the threads of the Final Filter. The POU Dispenser has an O-ring inside which provides a watertight seal.

B



- Press the Main Button to put the system into DISPENSING mode (B).
- For the SimFilter Final Filter, dispense about 0.5 Litre of water. For the BioPak Cartridge, refer to the instructions shipped with the filter.
- Press the Main Button. The system will finish dispensing water.
- Leave the system in PRE OPERATE mode.
- The Water System is now ready for use.

Maintenance

How to Calibrate the Tank Level (C03)

Before calibrating the tank level, the tank needs to be filled to the 100% level or TANK FULL.

- 1 Press the Main and "+" Buttons together to enter the menu. The Display will show C01.

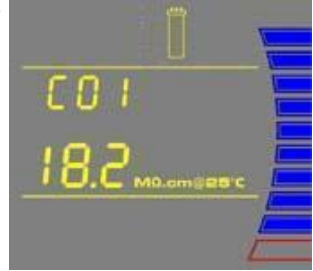

- 2 Press the Main Button 2 times. The Display will show C03. The highest Tank Level display will be blinking. This means that the highest water level is ready to be calibrated.

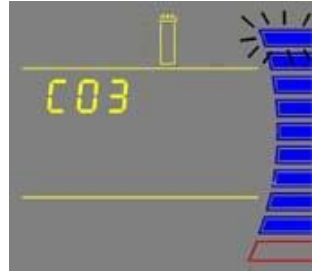

- 3 Press the "+" and "-" Buttons together to enter the highest water level. The Display will show the lowest Tank Level (red level) display blinking.

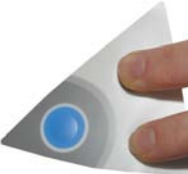

NOTE:

The highest and lowest tank level must be calibrated together or else the tank level is not calibrated.



Continued on next page

4



Remove the tank from the system. Remove the Vent Filter lid and empty all the water from the tank.

NOTE:

The lowest water level is not calibrated if the amount of water emptied from the tank is less than 10%.

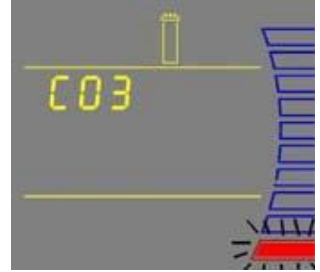

5



Reinstall the tank in the system.

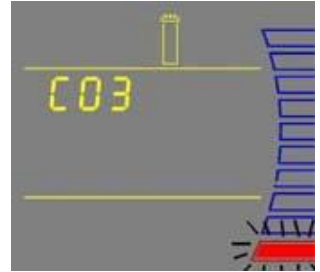

6



Press the "+" and "-" Buttons together to enter the lowest water level. The Display will exit the menu option and go into PRE OPERATE mode.

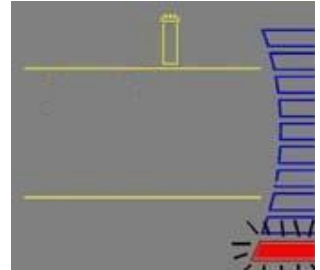

The Tank Level is now calibrated.

Refill the tank.

NOTE:

If the Display remains in the menu option and the highest tank level is blinking, then the tank level was not calibrated. The amount of water emptied from the tank was not enough (less than 10%). The tank needs to be emptied to its lowest water level. Fill the tank to the 100% level and perform the calibration again.

Maintenance

How to Replace the UV Lamp (UV System only)

The red UV Lamp Alarm will be blinking on the Display when it is time to exchange the UV Lamp. The message is shown when the UV Timer has reached 0 days (see *Section How to View or Reset the UV Lamp Timer (C04)*).



No electrical power should be going to the system at this time. Accidental exposure to ultraviolet light can cause damage to the eyes and skin.

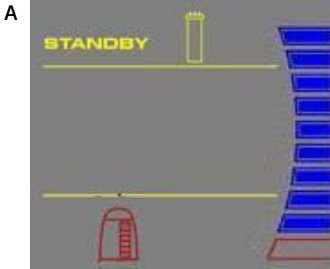

- Open the front cover to go into STANDBY mode (A).
-

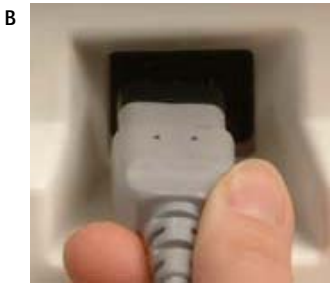

- Unplug the electrical cord to power OFF the system (B).
-



- Remove the Final Filter.
 - Remove the SimpliPak cartridge (C).
-

Removing the UV Lamp



The UV Lamp contains metallic Mercury. Please dispose of the used UV Lamp in a manner that is environmentally safe.

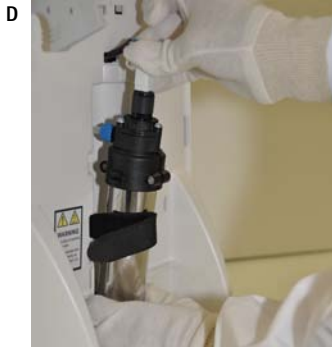

- Detach the Velcro® belt of the UV housing.
- Pull the UV housing out so that the UV Lamp cable is accessible (D).

NOTE:

Use the gloves supplied with the UV replacement kit.

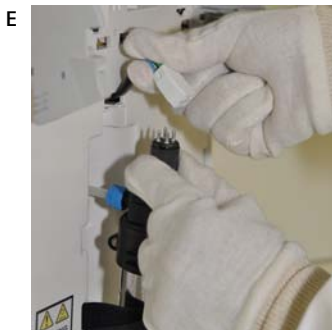

- Unplug the electrical cable from the UV Lamp (E).
-

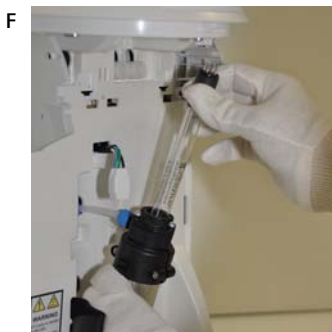

- Pull the UV Lamp out of the UV housing by its electrical cable (F).
-

Maintenance

Installing the new UV Lamp

G



- Ensure that you use the gloves supplied with the UV replacement kit. Plug the electrical cable to the new UV Lamp (G).

H



- Carefully insert the UV Lamp into the UV housing (H).

I



- Attach the UV housing with the Velcro belt (I).

J



- I Install the SimpliPak cartridge (J).
- Install the Final Filter.
- Close the front cover.
- Plug the electrical cord to power ON the system.
- Reset the UV Timer.
(See Section *How to View or Reset the UV Lamp Timer (C04)*).

How to View or Reset the UV Lamp Timer (C04)

The UV Lamp Timer should be reset only after the UV Lamp has been replaced (*see Section How to Replace the UV Lamp (UV System only)*). The UV Lamp Timer displays the time left until the UV Lamp needs to be replaced. The Display will show the red UV Lamp Alarm icon blinking when the Timer reaches 0 days. This message is displayed until the UV Lamp is replaced and the UV Lamp Timer is reset.

How to View the Remaining Days on the UV Lamp Timer

1



Press the Main and "+" Buttons together to enter the menu. The Display will show C01.

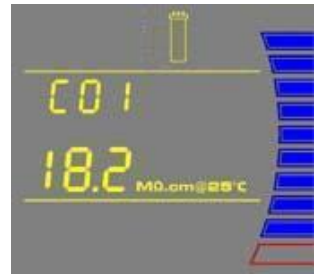

2



Press the Main Button 3 times. The Display will show C04 and the days left on the UV Timer.

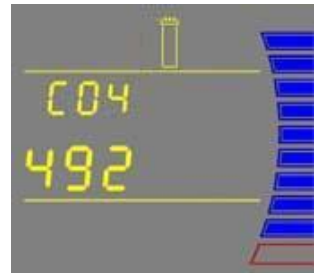

3



To exit the menu, press and hold the Main Button for 2 seconds.

To display the next menu option, press the Main Button once.

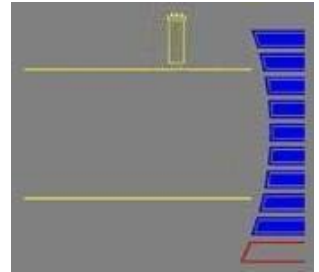

Maintenance

How to Reset the UV Lamp Timer

- 1 Press the Main and "+" Buttons together to enter the menu. The Display will show C01.

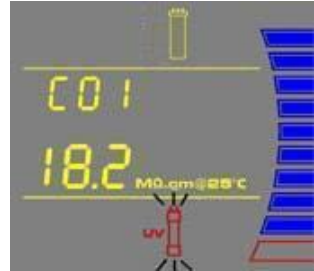

- 2 Press the Main Button 3 times. The Display will show C04 and "0" days left on the UV Timer.

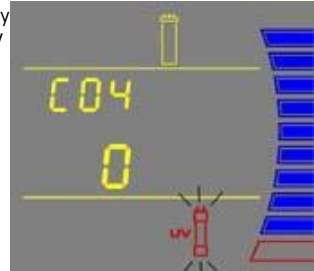

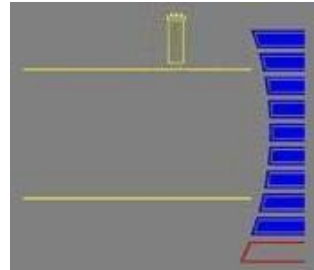

- 3 Press the "+" and "-" Buttons together. This will reset the UV Timer to 500 (days). The Display will exit the menu.



The UV Timer has been reset.

Troubleshooting

Problem	Possible causes	What to do
The Display screen is blank.	<ul style="list-style-type: none"> • The power cord is not plugged in. • No source of electrical power. • Main Power Fuse is blown. 	<ul style="list-style-type: none"> • Check that the power cord is plugged in. • Check the source of electrical power. • Contact your technical support.
Low water flow or no water flow when the Main Button is pressed (DISPENSING mode).	<ul style="list-style-type: none"> • The tank is empty. The Tank Level displays less than 10%. No dispensing is allowed. • The tank is not installed correctly or not installed at all. • Final Filter is clogged. 	<ul style="list-style-type: none"> • Refill the tank with pretreated water • Push in on the tank lid to fit the tank in place. This will allow the water level in the tank to be detected and properly displayed on the Display screen. • Replace the Final Filter, see <i>Section How to Replace the Final Filter</i>.
The last Product resistivity value is not displayed when you press the "-" Button in PRE OPERATE mode.	<ul style="list-style-type: none"> • A measurement was not made during DISPENSING mode or during recirculation. • The value is out of measurement range. 	<ul style="list-style-type: none"> • Dispense or recirculate water manually to start a Product resistivity measurement again.
	<ul style="list-style-type: none"> • The SimpliPak cartridge lifetime is exhausted. • The Product resistivity is less than the Resistivity Setpoint set in menu option C02. 	<ul style="list-style-type: none"> • Replace the SimpliPak cartridge. See <i>Section How to Replace the SimpliPak cartridge</i>.
	<ul style="list-style-type: none"> • The SimpliPak is not installed correctly or not installed at all. 	<ul style="list-style-type: none"> • Reinstall the SimpliPak. • If the red Pack Alarm is still displayed, then contact your technical support.

Troubleshooting

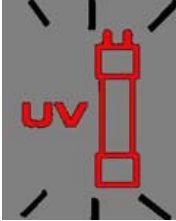
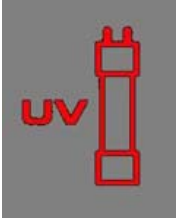
Problem	Possible causes	What to do
	<ul style="list-style-type: none"> The system may have been in STANDBY mode for a while. The Product resistivity is below the Resistivity Setpoint set in menu option C02. 	<ul style="list-style-type: none"> Recirculate the water in the system. See <i>Section How to recirculate water manually before dispensing.</i> Replace the SimpliPak. See <i>Section How to Replace the SimpliPak cartridge.</i>
 <p data-bbox="146 643 277 667">UV System only</p>	<ul style="list-style-type: none"> The UV Timer is exhausted. 	<ul style="list-style-type: none"> Replace the UV Lamp. See <i>Section How to Replace the UV Lamp (UV System only).</i> After a new UV Lamp has been installed, reset the UV Timer. See <i>Section How to View or Reset the UV Lamp Timer (C04).</i>
 <p data-bbox="146 946 277 970">UV System only</p>	<ul style="list-style-type: none"> The UV Lamp is not installed correctly or not installed at all. 	<ul style="list-style-type: none"> Power OFF the system and reinstall the UV Lamp. If the red UV Lamp Alarm is still displayed, then contact your technical support.

Catalogue Numbers for Simplicity Systems

For 230 VAC, 120 VAC, 100 VAC:

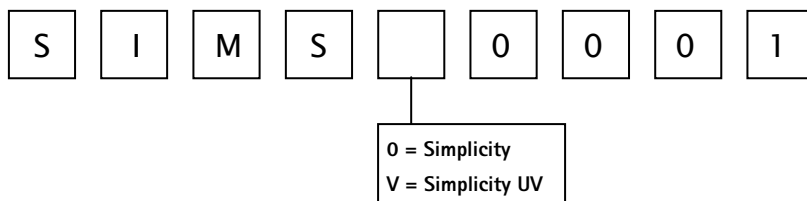

Catalogue Numbers for Consumables

Consumable Item	Catalogue Number
SimpliPak 1	SIPK0SIA1
SimpliPak 2	SIPK0SIX2
SimpliPak 3	SIPK0SIX3
Millex® Vent Filter (0.45 µm) – 10/box	SLFH02510
SimFilter Final Filter (0.05 µm) – 1/box	SIMFILTER
BioPak Ultrafiltration Cartridge	CDUFBI001
EDS-Pak™ Final Filter	EDSPAK001
VOC-Pak™ Final Filter	VOCPAK001
EDS-Pak Installation Kit - ordered 1 time only for multiple EDS-Pak uses.	EDSKIT001
UV Lamp 185 nm	SYN185UV1

Catalogue Numbers for Accessories

Accessory Item	Catalogue Number
Wall Mounting Bracket	WMBSMT002

Quick access to most common procedures

Contacting Millipore® SAS.....	2
How to recirculate water manually before dispensing	23
How to Replace the Final Filter	29
How to Replace the UV Lamp (UV System only)	32
How to Replace the SimpliPak cartridge.....	26



FTPF09582



V3.0